

# Detector / Signal

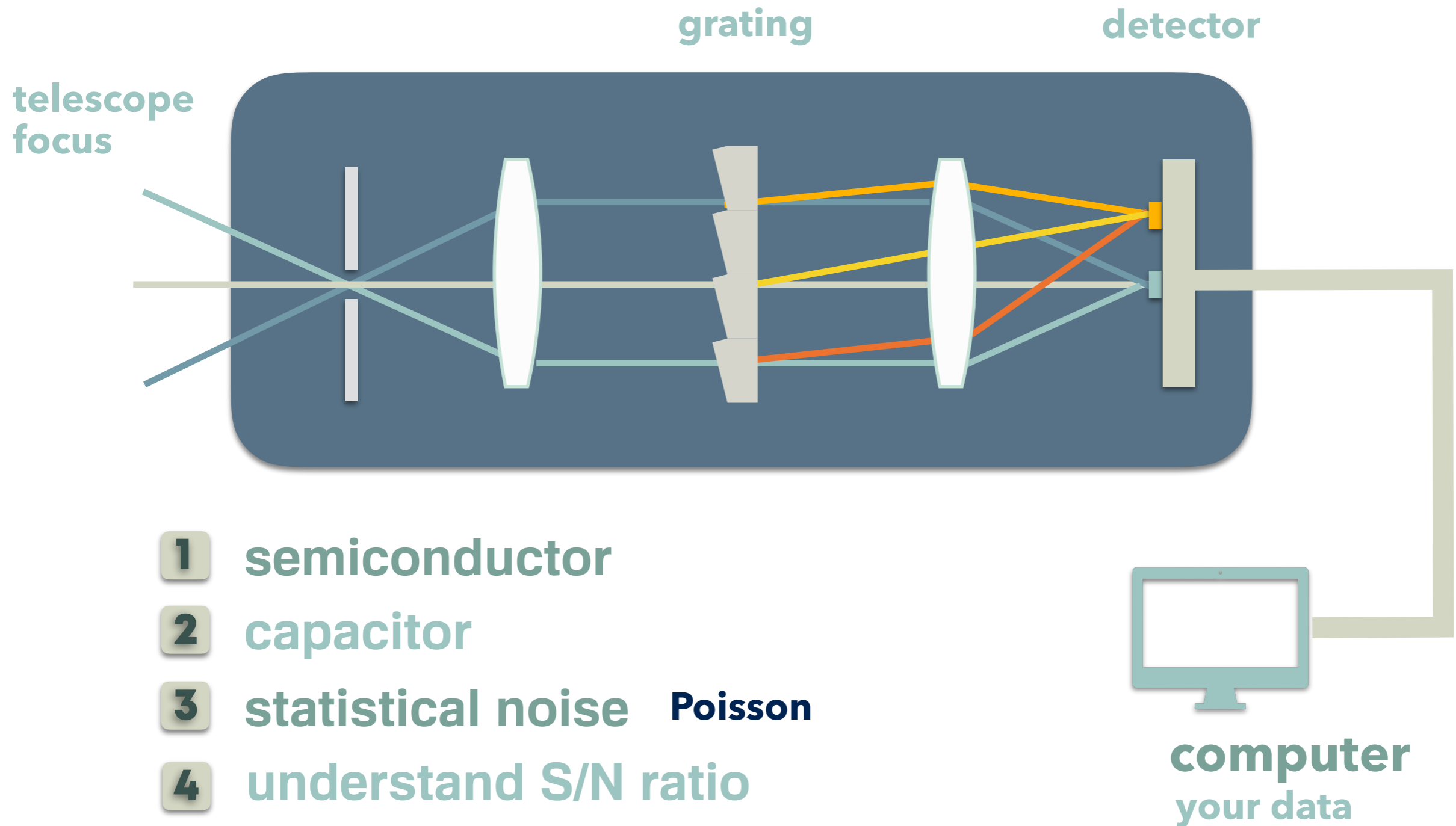

# Infrared detector

it is not CCD

it does not transfer charges

more like CMOS

signal of each pixel read separately

read out channel

detector  
sensitive to photons

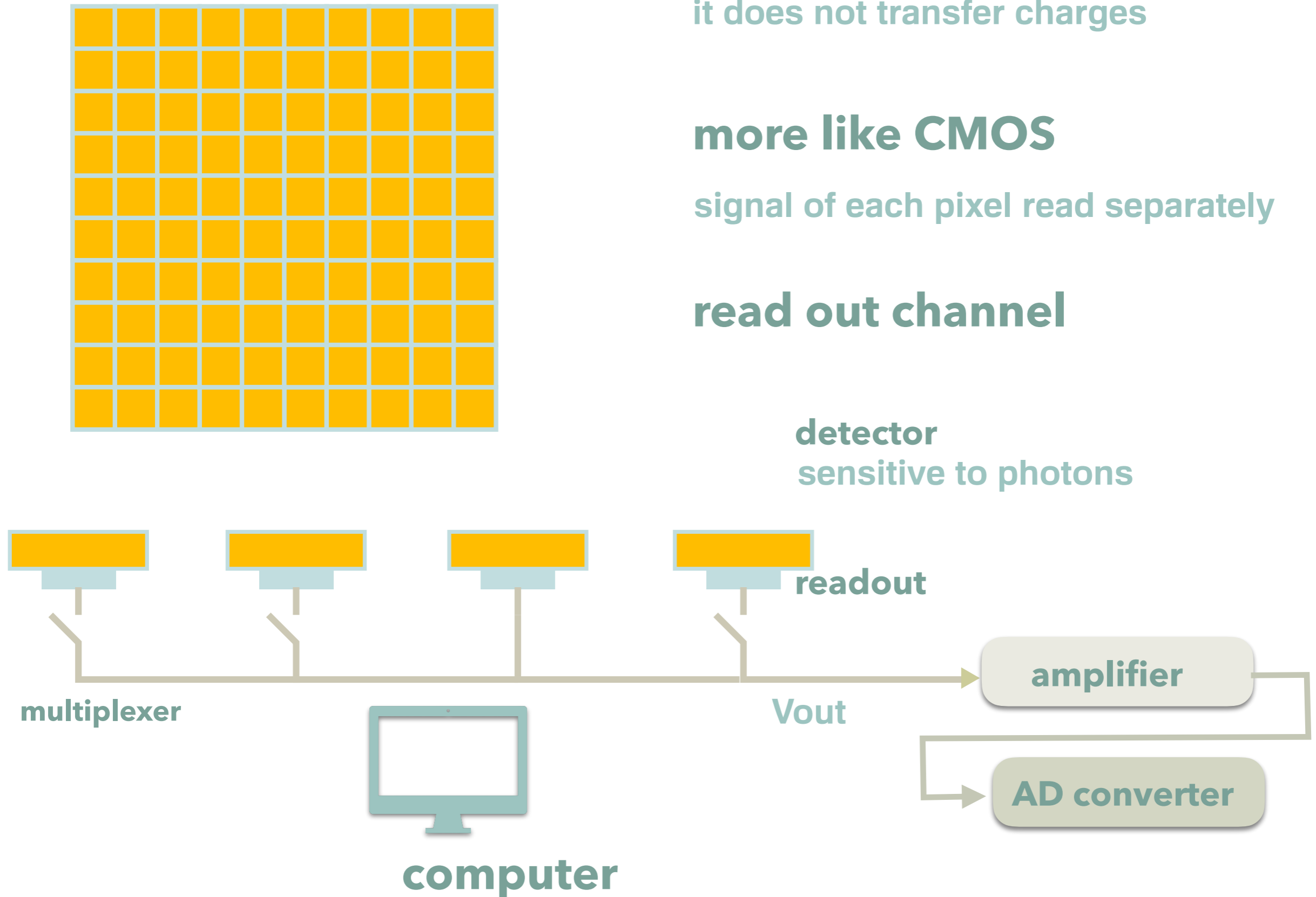

# single pixel

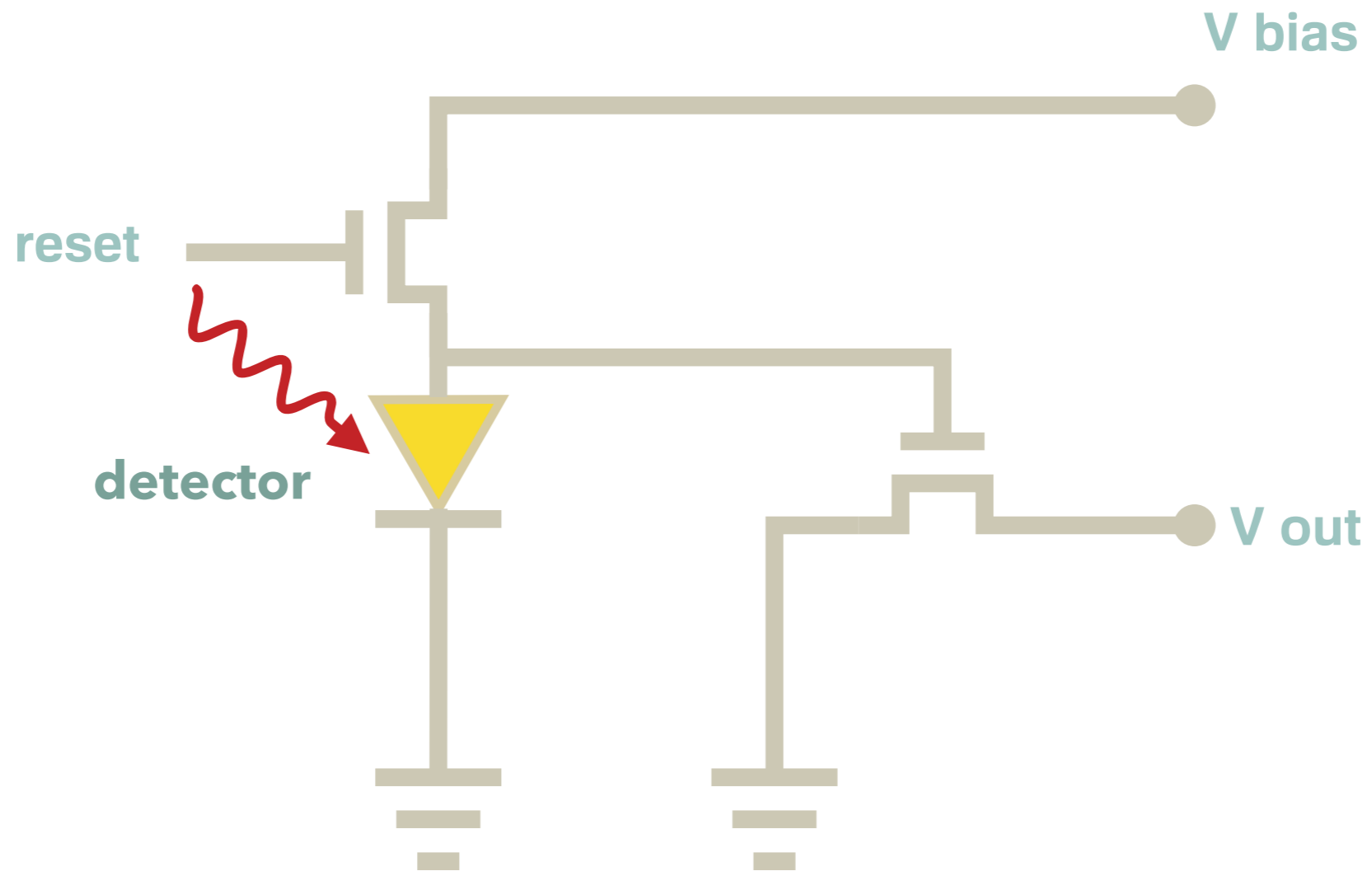

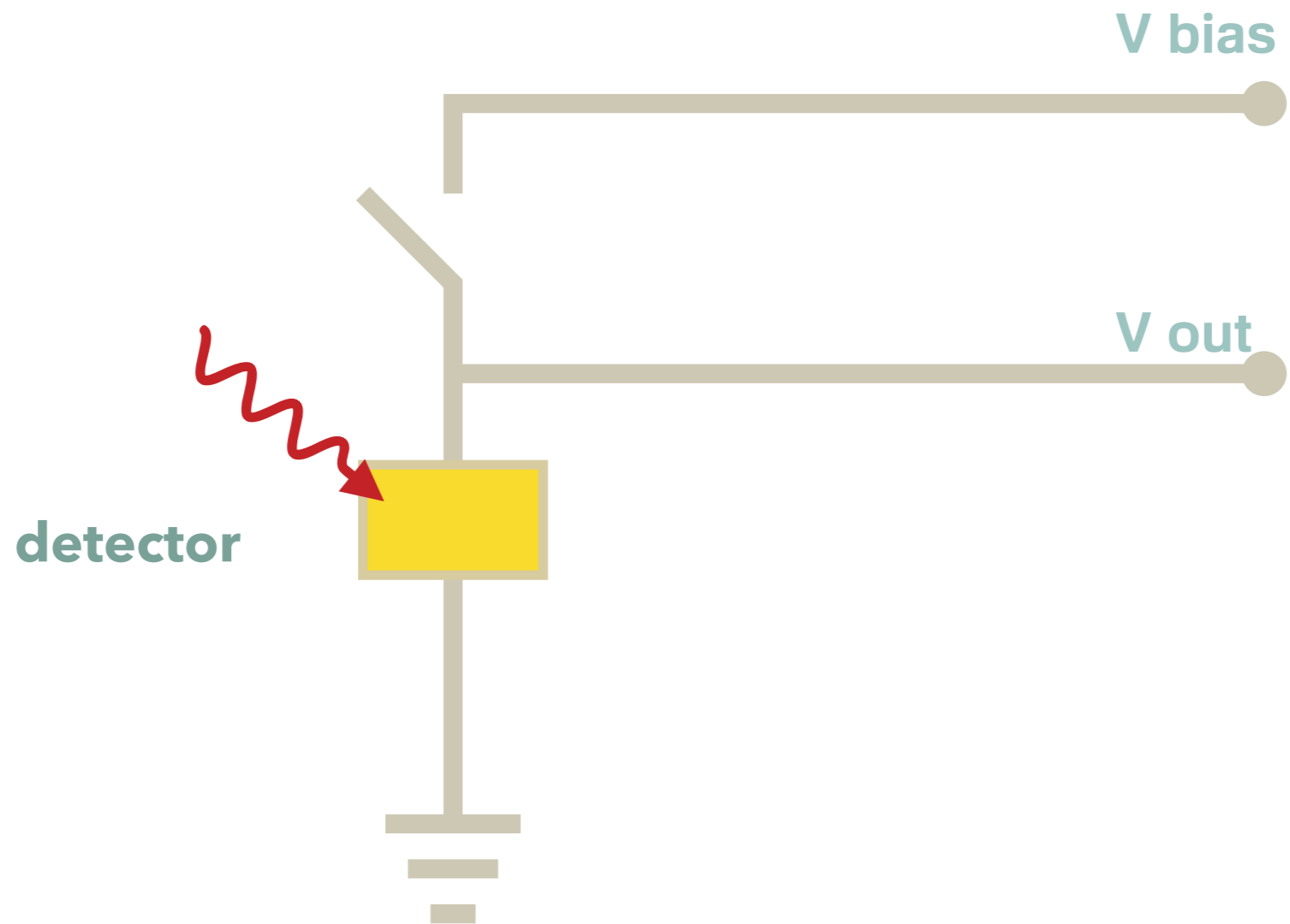

# Semiconductor

**metal**  
(conductor)



**glass**  
(insulator)

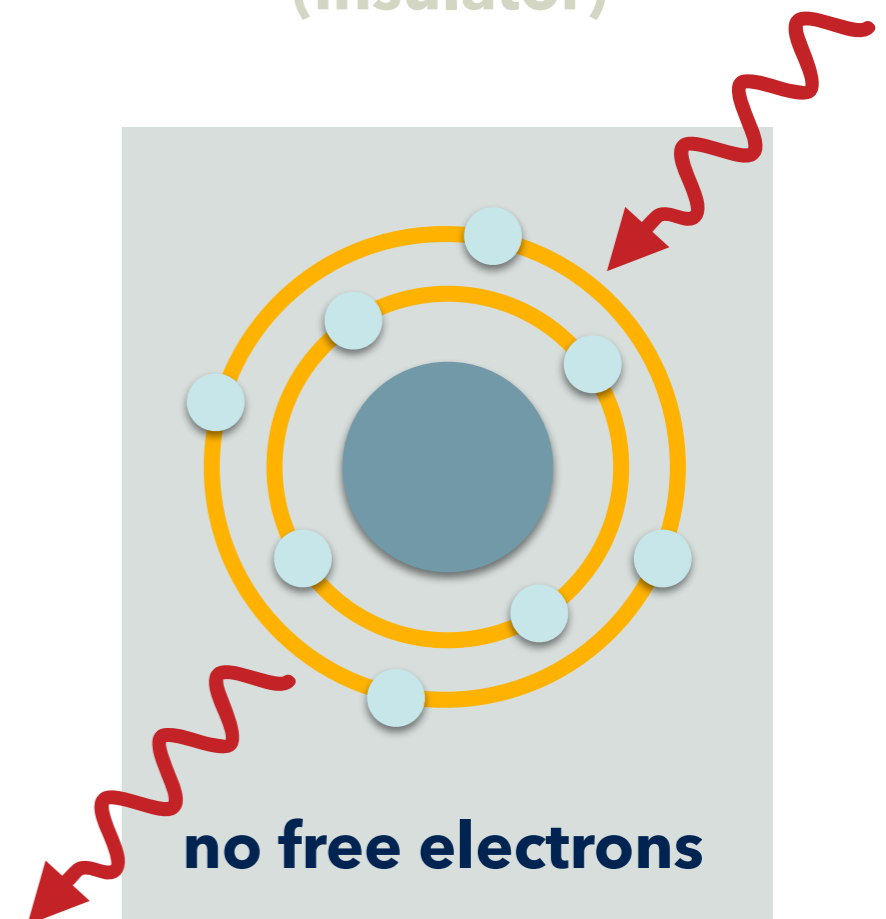

**not conductive**  
**no interaction with E**  
**no interaction with light**  
**transparent**

# Semiconductor

**metal**  
(conductor)

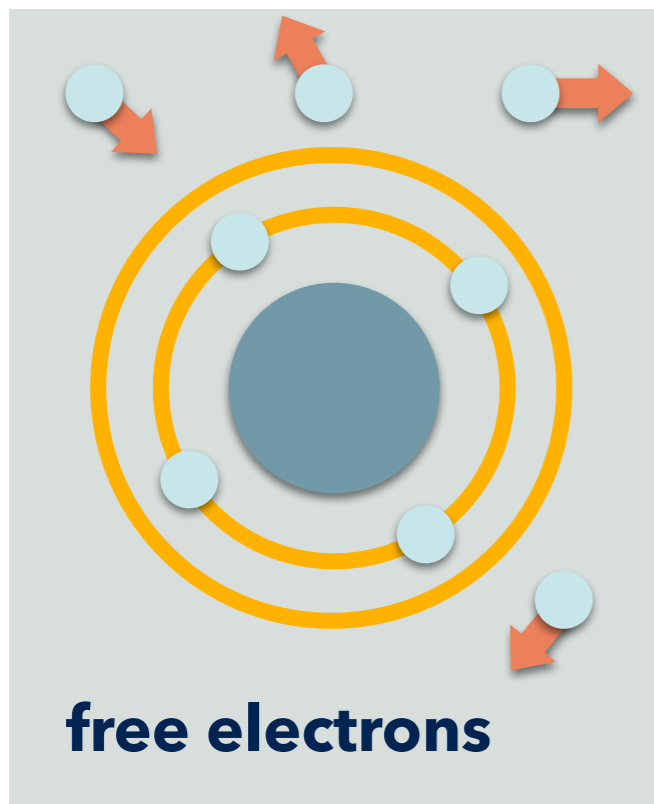

**silicon**  
(semiconductor)

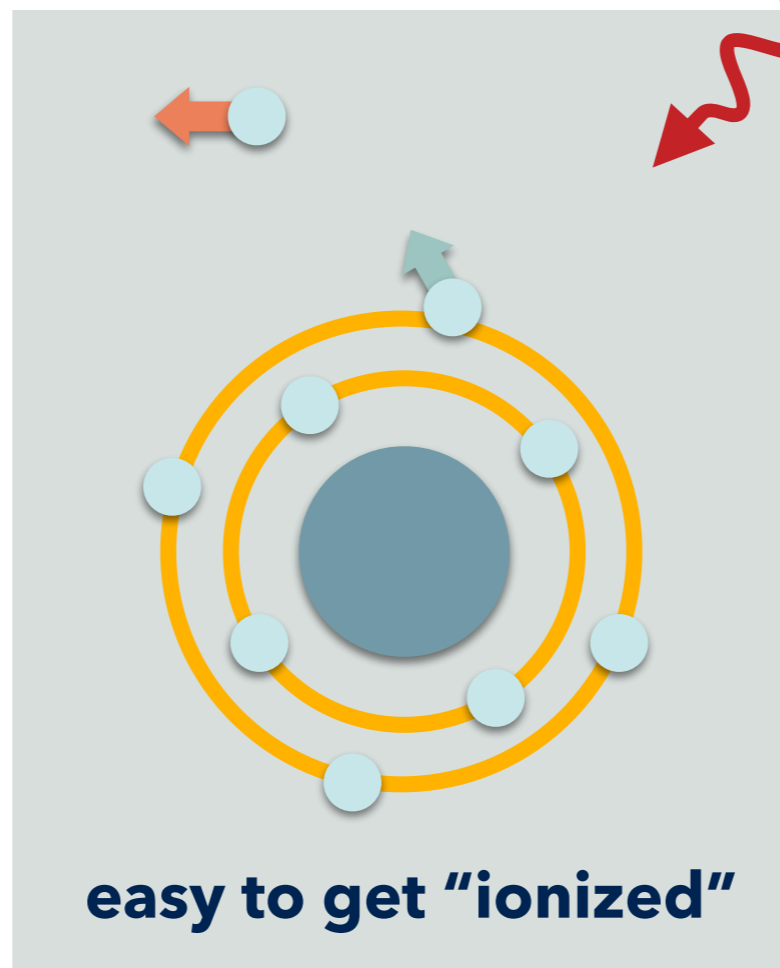

and get conductive

**glass**  
(insulator)

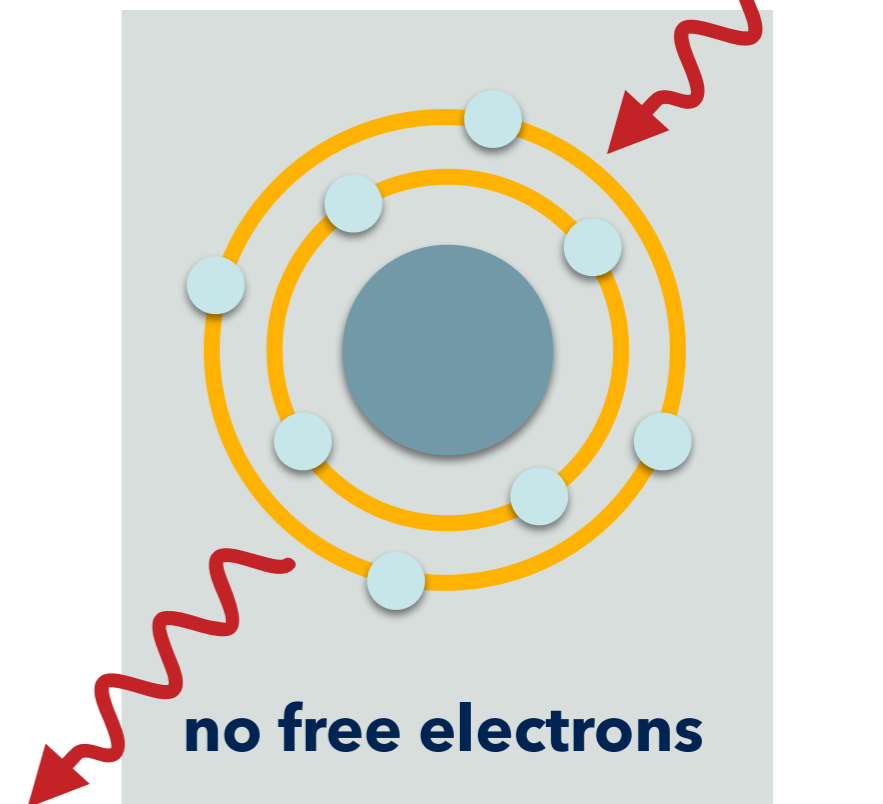

# IV semiconductor

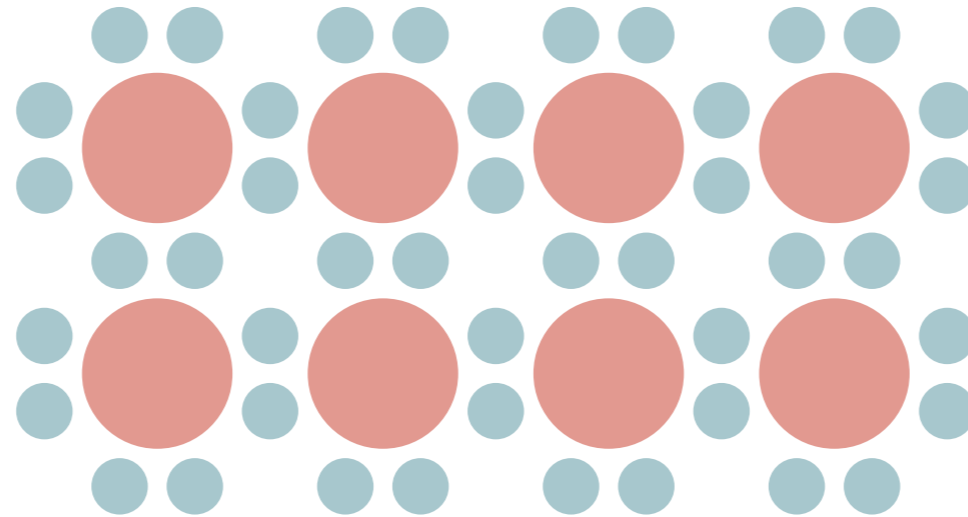
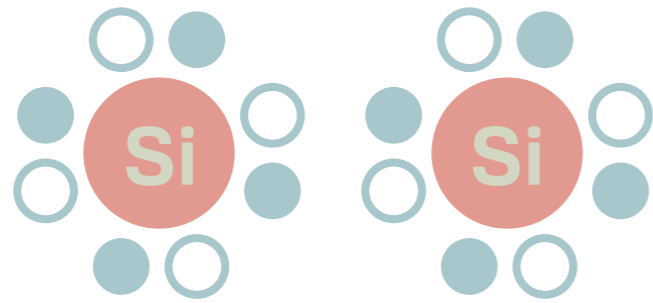



detector is a semiconductor

group IV

group III

group V

# Periodic Table of the Elements

1 1A 11A <b>H</b> Hydrogen 1.008	2 IIA 2A <b>He</b> Helium 4.003																	13 IIIA 3A <b>B</b> Boron 10.811	14 IVA 4A <b>C</b> Carbon 12.011	15 VA 5A <b>N</b> Nitrogen 14.007	16 VIA 6A <b>O</b> Oxygen 15.999	17 VIIA 7A <b>F</b> Fluorine 18.998	18 VIIIA 8A <b>Ne</b> Neon 20.180
3 <b>Li</b> Lithium 6.941	4 <b>Be</b> Beryllium 9.012																	5 <b>B</b> Boron 10.811	6 <b>C</b> Carbon 12.011	7 <b>N</b> Nitrogen 14.007	8 <b>O</b> Oxygen 15.999	9 <b>F</b> Fluorine 18.998	10 <b>Ne</b> Neon 20.180
11 <b>Na</b> Sodium 22.990	12 <b>Mg</b> Magnesium 24.305	3 IIIB 3B	4 IVB 4B	5 VB 5B	6 VIB 6B	7 VIIB 7B	8 VIII 8	9 VIII 9	10 VIII 10	11 IB 1B	12 IIB 2B	13 <b>Al</b> Aluminum 26.982	14 <b>Si</b> Silicon 28.086	15 <b>P</b> Phosphorus 30.974	16 <b>S</b> Sulfur 32.065	17 <b>Cl</b> Chlorine 35.453	18 <b>Ar</b> Argon 39.948						
19 <b>K</b> Potassium 39.098	20 <b>Ca</b> Calcium 40.078	21 <b>Sc</b> Scandium 44.956	22 <b>Ti</b> Titanium 47.88	23 <b>V</b> Vanadium 50.942	24 <b>Cr</b> Chromium 51.996	25 <b>Mn</b> Manganese 54.938	26 <b>Fe</b> Iron 55.845	27 <b>Co</b> Cobalt 58.933	28 <b>Ni</b> Nickel 58.693	29 <b>Cu</b> Copper 63.546	30 <b>Zn</b> Zinc 65.39	31 <b>Ga</b> Gallium 68.723	32 <b>Ge</b> Germanium 72.61	33 <b>As</b> Arsenic 74.922	34 <b>Se</b> Selenium 78.96	35 <b>Br</b> Bromine 79.904	36 <b>Kr</b> Krypton 84.80						
37 <b>Rb</b> Rubidium 84.468	38 <b>Sr</b> Strontium 87.62	39 <b>Y</b> Yttrium 88.906	40 <b>Zr</b> Zirconium 91.224	41 <b>Nb</b> Niobium 92.906	42 <b>Mo</b> Molybdenum 95.94	43 <b>Tc</b> Technetium 98.907	44 <b>Ru</b> Ruthenium 101.07	45 <b>Rh</b> Rhodium 102.906	46 <b>Pd</b> Palladium 106.42	47 <b>Ag</b> Silver 107.868	48 <b>Cd</b> Cadmium 112.411	49 <b>In</b> Indium 114.818	50 <b>Sn</b> Tin 118.71	51 <b>Sb</b> Antimony 121.760	52 <b>Te</b> Tellurium 127.6	53 <b>I</b> Iodine 126.904	54 <b>Xe</b> Xenon 131.29						
55 <b>Cs</b> Cesium 132.905	56 <b>Ba</b> Barium 137.327	57-71	72 <b>Hf</b> Hafnium 178.49	73 <b>Ta</b> Tantalum 180.948	74 <b>W</b> Tungsten 183.85	75 <b>Re</b> Rhenium 186.207	76 <b>Os</b> Osmium 190.23	77 <b>Ir</b> Iridium 192.22	78 <b>Pt</b> Platinum 195.08	79 <b>Au</b> Gold 196.967	80 <b>Hg</b> Mercury 200.59	81 <b>Tl</b> Thallium 204.383	82 <b>Pb</b> Lead 207.2	83 <b>Bi</b> Bismuth 208.980	84 <b>Po</b> Polonium [209]	85 <b>At</b> Astatine [210]	86 <b>Rn</b> Radon 222.018						
87 <b>Fr</b> Francium [223]	88 <b>Ra</b> Radium [226]	89-103	104 <b>Rf</b> Rutherfordium [261]	105 <b>Db</b> Dubnium [262]	106 <b>Sg</b> Seaborgium [266]	107 <b>Bh</b> Bohrium [264]	108 <b>Hs</b> Hassium [269]	109 <b>Mt</b> Meitnerium [268]	110 <b>Ds</b> Darmstadtium [269]	111 <b>Rg</b> Roentgenium [272]	112 <b>Cn</b> Copernicium [277]	113 <b>Uut</b> Ununtrium unknown	114 <b>F1</b> Flerovium [289]	115 <b>Uup</b> Ununpentium unknown	116 <b>Lv</b> Livermorium [293]	117 <b>Uus</b> Ununseptium unknown	118 <b>Uuo</b> Ununoctium unknown						

Lanthanide Series	57 <b>La</b> Lanthanum 138.905	58 <b>Ce</b> Cerium 140.116	59 <b>Pr</b> Praseodymium 140.908	60 <b>Nd</b> Neodymium 144.24	61 <b>Pm</b> Promethium [145]	62 <b>Sm</b> Samarium 150.36	63 <b>Eu</b> Europium 151.964	64 <b>Gd</b> Gadolinium 157.25	65 <b>Tb</b> Terbium 158.925	66 <b>Dy</b> Dysprosium 162.50	67 <b>Ho</b> Holmium 164.930	68 <b>Er</b> Erbium 167.256	69 <b>Tm</b> Thulium 168.934	70 <b>Yb</b> Ytterbium 173.054	71 <b>Lu</b> Lutetium 174.967
Actinide Series	89 <b>Ac</b> Actinium 227.028	90 <b>Th</b> Thorium 232.038	91 <b>Pa</b> Protactinium 231.036	92 <b>U</b> Uranium 238.029	93 <b>Np</b> Neptunium 237.048	94 <b>Pu</b> Plutonium 244.064	95 <b>Am</b> Americium 243.061	96 <b>Cm</b> Curium 247.070	97 <b>Bk</b> Berkelium 247.070	98 <b>Cf</b> Californium 251.080	99 <b>Es</b> Einsteinium [254]	100 <b>Fm</b> Fermium 257.095	101 <b>Md</b> Mendelevium 258.1	102 <b>No</b> Nobelium 259.101	103 <b>Lr</b> Lawrencium [262]

Alkali Metal	Alkaline Earth	Transition Metal	Semimetal	Nonmetal	Basic Metal	Halogen	Noble Gas	Lanthanide	Actinide
--------------	----------------	------------------	-----------	----------	-------------	---------	-----------	------------	----------



# IV semiconductor

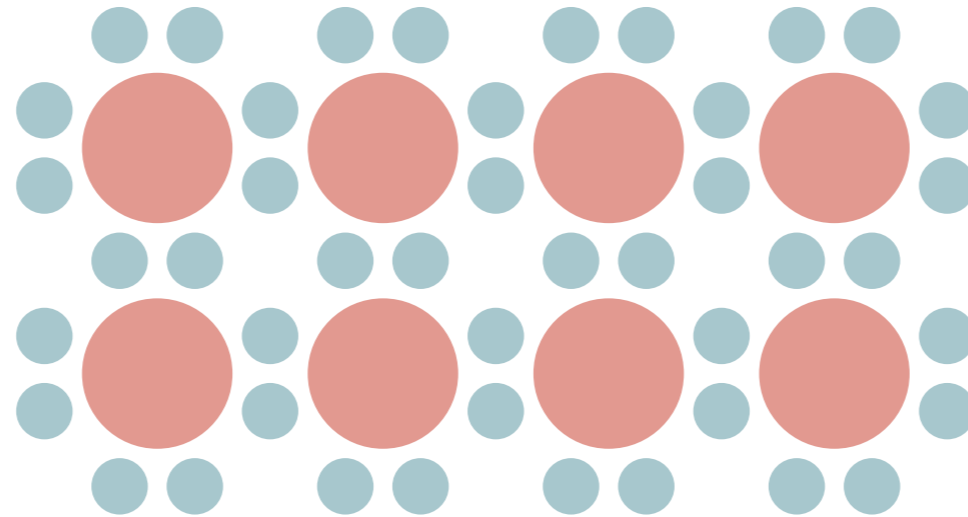
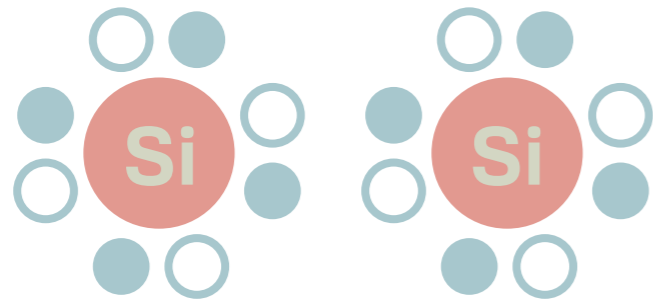

detector is a semiconductor

group IV

group III

group V

Periodic Table of the Elements

1 1A 11A <b>H</b> Hydrogen 1.008	2 IIA 2A <b>He</b> Helium 4.003																	13 IIIA 3A <b>B</b> Boron 10.811	14 IVA 4A <b>C</b> Carbon 12.011	15 VA 5A <b>N</b> Nitrogen 14.007	16 VIA 6A <b>O</b> Oxygen 15.999	17 VIIA 7A <b>F</b> Fluorine 18.998	18 VIIIA 8A <b>Ne</b> Neon 20.180
3 <b>Li</b> Lithium 6.941	4 <b>Be</b> Beryllium 9.012																	5 <b>B</b> Boron 10.811	6 <b>C</b> Carbon 12.011	7 <b>N</b> Nitrogen 14.007	8 <b>O</b> Oxygen 15.999	9 <b>F</b> Fluorine 18.998	10 <b>Ne</b> Neon 20.180
11 <b>Na</b> Sodium 22.990	12 <b>Mg</b> Magnesium 24.305	3 IIIB 3B	4 IVB 4B	5 VB 5B	6 VIB 6B	7 VIIB 7B	8 VIII 8	9 VIII 9	10 VIII 10	11 IB 1B	12 IIB 2B	13 <b>Al</b> Aluminum 26.982	14 <b>Si</b> Silicon 28.086	15 <b>P</b> Phosphorus 30.974	16 <b>S</b> Sulfur 32.065	17 <b>Cl</b> Chlorine 35.453	18 <b>Ar</b> Argon 39.948						
19 <b>K</b> Potassium 39.098	20 <b>Ca</b> Calcium 40.078	21 <b>Sc</b> Scandium 44.956	22 <b>Ti</b> Titanium 47.88	23 <b>V</b> Vanadium 50.942	24 <b>Cr</b> Chromium 51.996	25 <b>Mn</b> Manganese 54.938	26 <b>Fe</b> Iron 55.845	27 <b>Co</b> Cobalt 58.933	28 <b>Ni</b> Nickel 58.693	29 <b>Cu</b> Copper 63.546	30 <b>Zn</b> Zinc 65.39	31 <b>Ga</b> Gallium 68.923	32 <b>Ge</b> Germanium 72.61	33 <b>As</b> Arsenic 74.922	34 <b>Se</b> Selenium 78.96	35 <b>Br</b> Bromine 79.904	36 <b>Kr</b> Krypton 84.80						
37 <b>Rb</b> Rubidium 84.468	38 <b>Sr</b> Strontium 87.62	39 <b>Y</b> Yttrium 88.906	40 <b>Zr</b> Zirconium 91.224	41 <b>Nb</b> Niobium 92.906	42 <b>Mo</b> Molybdenum 95.94	43 <b>Tc</b> Technetium 98.907	44 <b>Ru</b> Ruthenium 101.07	45 <b>Rh</b> Rhodium 102.906	46 <b>Pd</b> Palladium 106.42	47 <b>Ag</b> Silver 107.868	48 <b>Cd</b> Cadmium 112.411	49 <b>In</b> Indium 114.818	50 <b>Sn</b> Tin 118.71	51 <b>Sb</b> Antimony 121.760	52 <b>Te</b> Tellurium 127.6	53 <b>I</b> Iodine 126.904	54 <b>Xe</b> Xenon 131.29						
55 <b>Cs</b> Cesium 132.905	56 <b>Ba</b> Barium 137.327	57-71	72 <b>Hf</b> Hafnium 178.49	73 <b>Ta</b> Tantalum 180.948	74 <b>W</b> Tungsten 183.85	75 <b>Re</b> Rhenium 186.207	76 <b>Os</b> Osmium 190.23	77 <b>Ir</b> Iridium 192.22	78 <b>Pt</b> Platinum 195.08	79 <b>Au</b> Gold 196.967	80 <b>Hg</b> Mercury 200.59	81 <b>Tl</b> Thallium 204.383	82 <b>Pb</b> Lead 207.2	83 <b>Bi</b> Bismuth 208.980	84 <b>Po</b> Polonium [209]	85 <b>At</b> Astatine [210]	86 <b>Rn</b> Radon 222.018						
87 <b>Fr</b> Francium [223]	88 <b>Ra</b> Radium [226]	89-103	104 <b>Rf</b> Rutherfordium [261]	105 <b>Db</b> Dubnium [262]	106 <b>Sg</b> Seaborgium [266]	107 <b>Bh</b> Bohrium [264]	108 <b>Hs</b> Hassium [269]	109 <b>Mt</b> Meitnerium [268]	110 <b>Ds</b> Darmstadtium [269]	111 <b>Rg</b> Roentgenium [272]	112 <b>Cn</b> Copernicium [277]	113 <b>Uut</b> Ununtrium [278]	114 <b>F1</b> Flerovium [277]	115 <b>Uup</b> Ununpentium [278]	116 <b>Lv</b> Livermorium [276]	117 <b>Uus</b> Ununseptium [270]	118 <b>Uuo</b> Ununoctium [277]						

Lanthanide Series	57 <b>La</b> Lanthanum 138.905	58 <b>Ce</b> Cerium 140.116	59 <b>Pr</b> Praseodymium 140.908	60 <b>Nd</b> Neodymium 144.24	61 <b>Pm</b> Promethium [145]	62 <b>Sm</b> Samarium 150.36	63 <b>Eu</b> Europium 151.964	64 <b>Gd</b> Gadolinium 157.25	65 <b>Tb</b> Terbium 158.925	66 <b>Dy</b> Dysprosium 162.50	67 <b>Ho</b> Holmium 164.930	68 <b>Er</b> Erbium 167.255	69 <b>Tm</b> Thulium 168.934	70 <b>Yb</b> Ytterbium 173.04	71 <b>Lu</b> Lutetium 174.967
Actinide Series	89 <b>Ac</b> Actinium 227.028	90 <b>Th</b> Thorium 232.038	91 <b>Pa</b> Protactinium 231.036	92 <b>U</b> Uranium 238.029	93 <b>Np</b> Neptunium 237.048	94 <b>Pu</b> Plutonium 244.064	95 <b>Am</b> Americium 243.061	96 <b>Cm</b> Curium 247.070	97 <b>Bk</b> Berkelium 247.070	98 <b>Cf</b> Californium 251.080	99 <b>Es</b> Einsteinium [252]	100 <b>Fm</b> Fermium 257.095	101 <b>Md</b> Mendelevium 258.1	102 <b>No</b> Nobelium 259.101	103 <b>Lr</b> Lawrencium [262]

- Alkali Metal
- Alkaline Earth
- Transition Metal
- Semimetal
- Nonmetal
- Basic Metal
- Halogen
- Noble Gas
- Lanthanide
- Actinide

# III V semiconductor

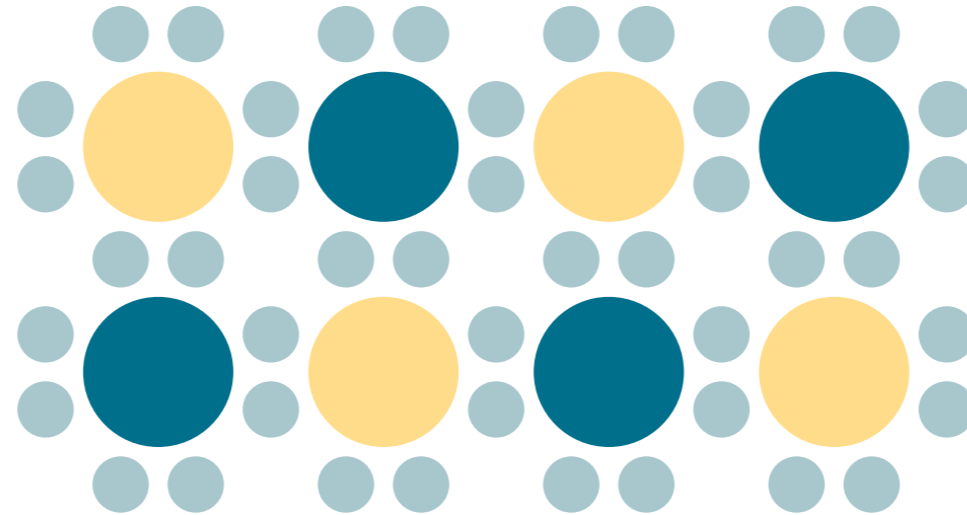



# Periodic Table of the Elements

													group VI							
1 IA 11A													13 IIIA 3A	14 IVA 4A	15 VA 5A	16 VIA 6A	17 VIIA 7A	18 VIIIA 8A		
1 <b>H</b> Hydrogen 1.008													5 <b>B</b> Boron 10.811	6 <b>C</b> Carbon 12.011	7 <b>N</b> Nitrogen 14.007	8 <b>O</b> Oxygen 15.999	9 <b>F</b> Fluorine 18.998	10 <b>Ne</b> Neon 20.180		
3 <b>Li</b> Lithium 6.941	4 <b>Be</b> Beryllium 9.012											group II								
11 <b>Na</b> Sodium 22.990	12 <b>Mg</b> Magnesium 24.305											11 IB 1B	12 IIB 2B	13 IIIA 3A	14 IVA 4A	15 VA 5A	16 VIA 6A	17 VIIA 7A	18 VIIIA 8A	
19 <b>K</b> Potassium 39.098	20 <b>Ca</b> Calcium 40.078	21 <b>Sc</b> Scandium 44.956	22 <b>Ti</b> Titanium 47.88	23 <b>V</b> Vanadium 50.942	24 <b>Cr</b> Chromium 51.996	25 <b>Mn</b> Manganese 54.938	26 <b>Fe</b> Iron 55.845	27 <b>Co</b> Cobalt 58.933	28 <b>Ni</b> Nickel 58.693	29 <b>Cu</b> Copper 63.546	30 <b>Zn</b> Zinc 65.39	31 <b>Ga</b> Gallium 68.732	32 <b>Ge</b> Germanium 72.61	33 <b>As</b> Arsenic 74.922	34 <b>Se</b> Selenium 78.96	35 <b>Br</b> Bromine 79.904	36 <b>Kr</b> Krypton 84.80			
37 <b>Rb</b> Rubidium 84.468	38 <b>Sr</b> Strontium 87.62	39 <b>Y</b> Yttrium 88.906	40 <b>Zr</b> Zirconium 91.224	41 <b>Nb</b> Niobium 92.906	42 <b>Mo</b> Molybdenum 95.94	43 <b>Tc</b> Technetium 98.906	44 <b>Ru</b> Ruthenium 101.07	45 <b>Rh</b> Rhodium 102.906	46 <b>Pd</b> Palladium 106.42	47 <b>Ag</b> Silver 107.868	48 <b>Cd</b> Cadmium 112.411	49 <b>In</b> Indium 114.818	50 <b>Sn</b> Tin 118.71	51 <b>Sb</b> Antimony 121.760	52 <b>Te</b> Tellurium 127.6	53 <b>I</b> Iodine 126.904	54 <b>Xe</b> Xenon 131.29			
55 <b>Cs</b> Cesium 132.905	56 <b>Ba</b> Barium 137.327	57-71	72 <b>Hf</b> Hafnium 178.49	73 <b>Ta</b> Tantalum 180.948	74 <b>W</b> Tungsten 183.85	75 <b>Re</b> Rhenium 186.207	76 <b>Os</b> Osmium 190.23	77 <b>Ir</b> Iridium 192.22	78 <b>Pt</b> Platinum 195.08	79 <b>Au</b> Gold 196.967	80 <b>Hg</b> Mercury 200.59	81 <b>Tl</b> Thallium 204.383	82 <b>Pb</b> Lead 207.2	83 <b>Bi</b> Bismuth 208.980	84 <b>Po</b> Polonium [209]	85 <b>At</b> Astatine [210]	86 <b>Rn</b> Radon 222.018			
87 <b>Fr</b> Francium [223]	88 <b>Ra</b> Radium [226]	89-103	104 <b>Rf</b> Rutherfordium [261]	105 <b>Db</b> Dubnium [262]	106 <b>Sg</b> Seaborgium [266]	107 <b>Bh</b> Bohrium [264]	108 <b>Hs</b> Hassium [285]	109 <b>Mt</b> Meitnerium [268]	110 <b>Ds</b> Darmstadtium [289]	111 <b>Rg</b> Roentgenium [272]	112 <b>Cn</b> Copernicium [285]	113 <b>Uut</b> Ununtrium unknown	114 <b>Fl</b> Flerovium [289]	115 <b>Uup</b> Ununpentium unknown	116 <b>Lv</b> Livermorium [293]	117 <b>Uus</b> Ununseptium unknown	118 <b>Uuo</b> Ununoctium unknown			

Lanthanide Series	57 <b>La</b> Lanthanum 138.905	58 <b>Ce</b> Cerium 140.116	59 <b>Pr</b> Praseodymium 140.908	60 <b>Nd</b> Neodymium 144.24	61 <b>Pm</b> Promethium [144.913]	62 <b>Sm</b> Samarium 150.36	63 <b>Eu</b> Europium 151.964	64 <b>Gd</b> Gadolinium 157.25	65 <b>Tb</b> Terbium 158.925	66 <b>Dy</b> Dysprosium 162.50	67 <b>Ho</b> Holmium 164.930	68 <b>Er</b> Erbium 167.256	69 <b>Tm</b> Thulium 168.934	70 <b>Yb</b> Ytterbium 173.054	71 <b>Lu</b> Lutetium 174.967
Actinide Series	89 <b>Ac</b> Actinium 227.028	90 <b>Th</b> Thorium 232.038	91 <b>Pa</b> Protactinium 231.036	92 <b>U</b> Uranium 238.029	93 <b>Np</b> Neptunium 237.048	94 <b>Pu</b> Plutonium 244.064	95 <b>Am</b> Americium 243.061	96 <b>Cm</b> Curium 247.070	97 <b>Bk</b> Berkelium 247.070	98 <b>Cf</b> Californium 251.080	99 <b>Es</b> Einsteinium [254]	100 <b>Fm</b> Fermium 257.095	101 <b>Md</b> Mendelevium 258.1	102 <b>No</b> Nobelium 259.101	103 <b>Lr</b> Lawrencium [262]

Alkali Metal	Alkaline Earth	Transition Metal	Semimetal	Nonmetal	Basic Metal	Halogen	Noble Gas	Lanthanide	Actinide
--------------	----------------	------------------	-----------	----------	-------------	---------	-----------	------------	----------

II-VI semiconductor

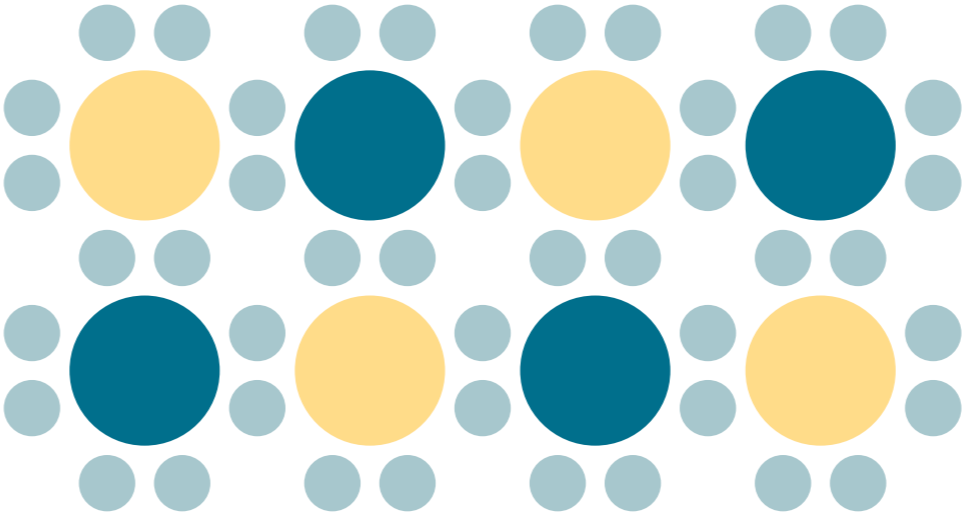
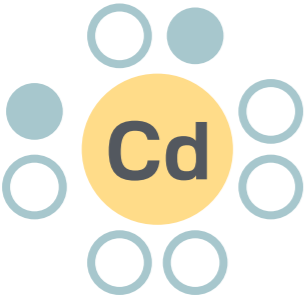

# Doping

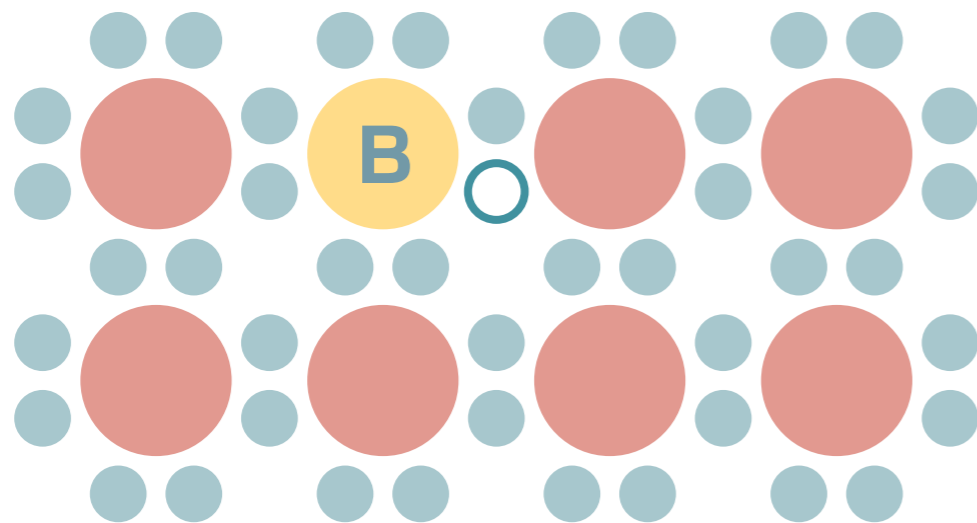
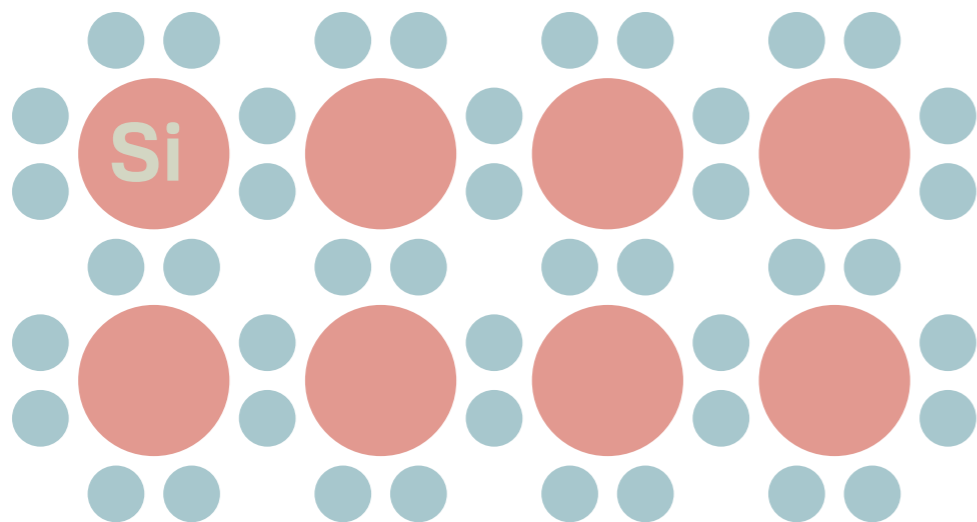

**p type**  
conductive

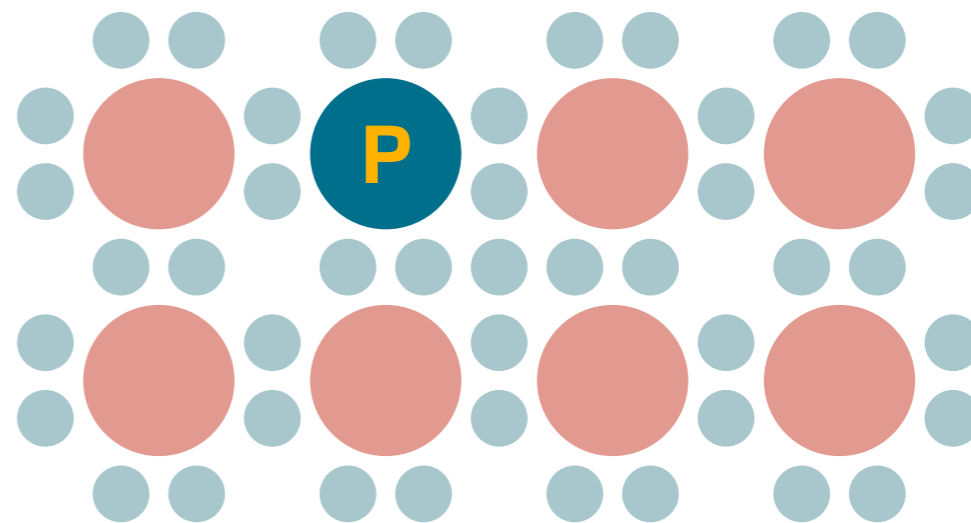

**n type**  
conductive

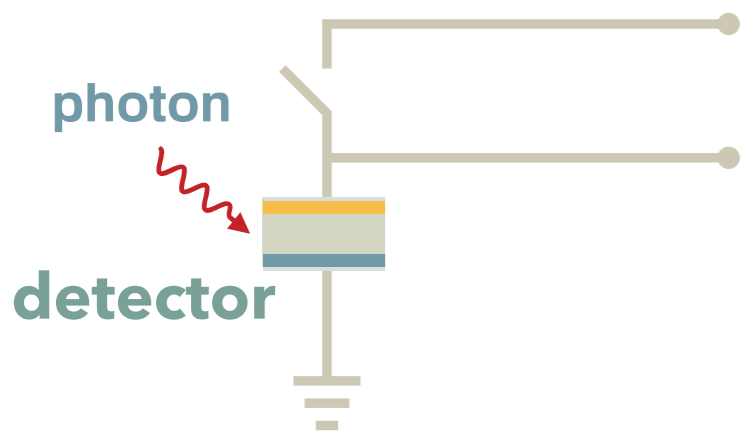

**p-type holes**      **n-type electrons**

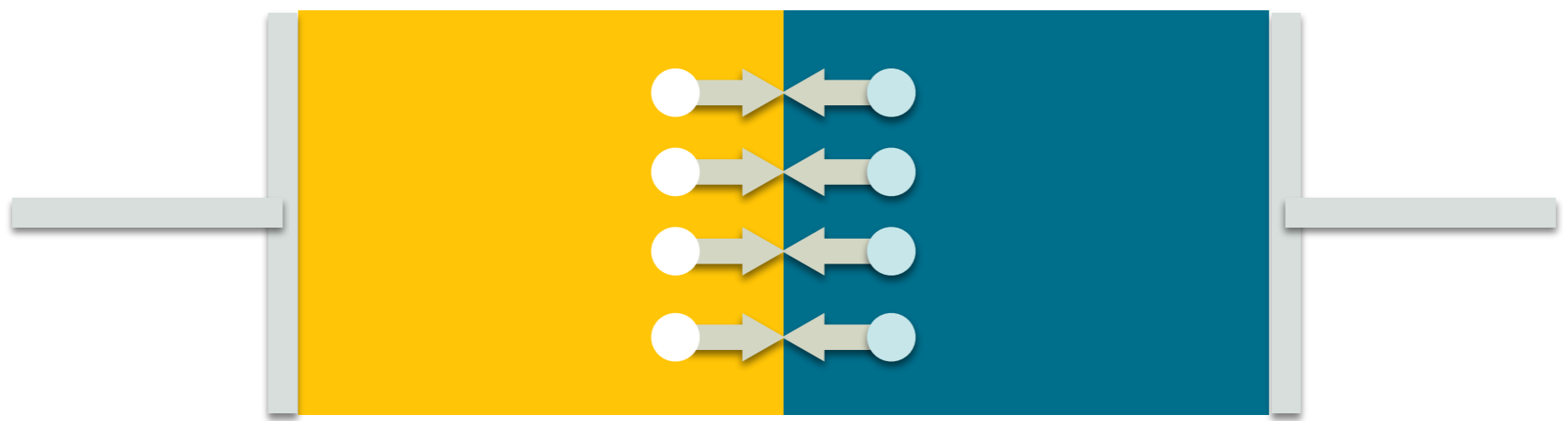

depletion zone



**non-conductive**



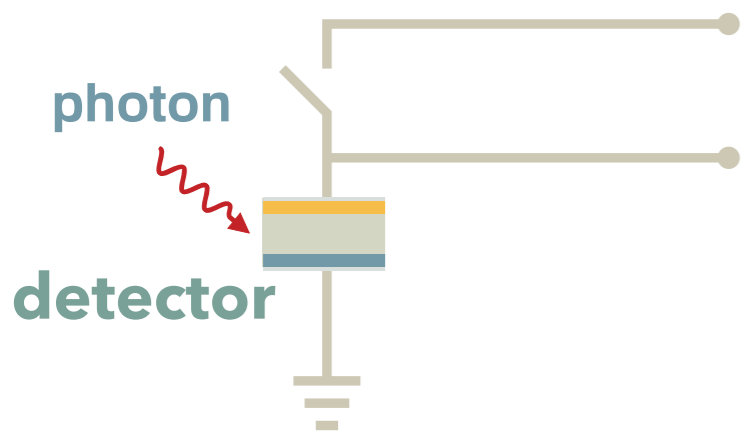

**p-type holes**      **n-type electrons**

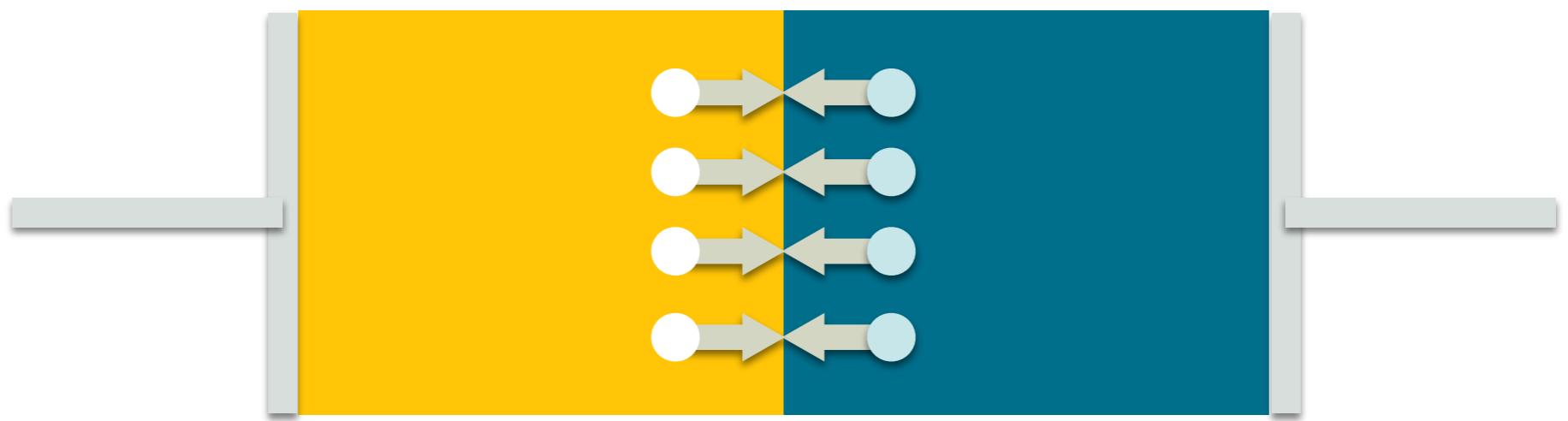

$V_{\text{bias}}$

+

depletion zone



**non-conductive**

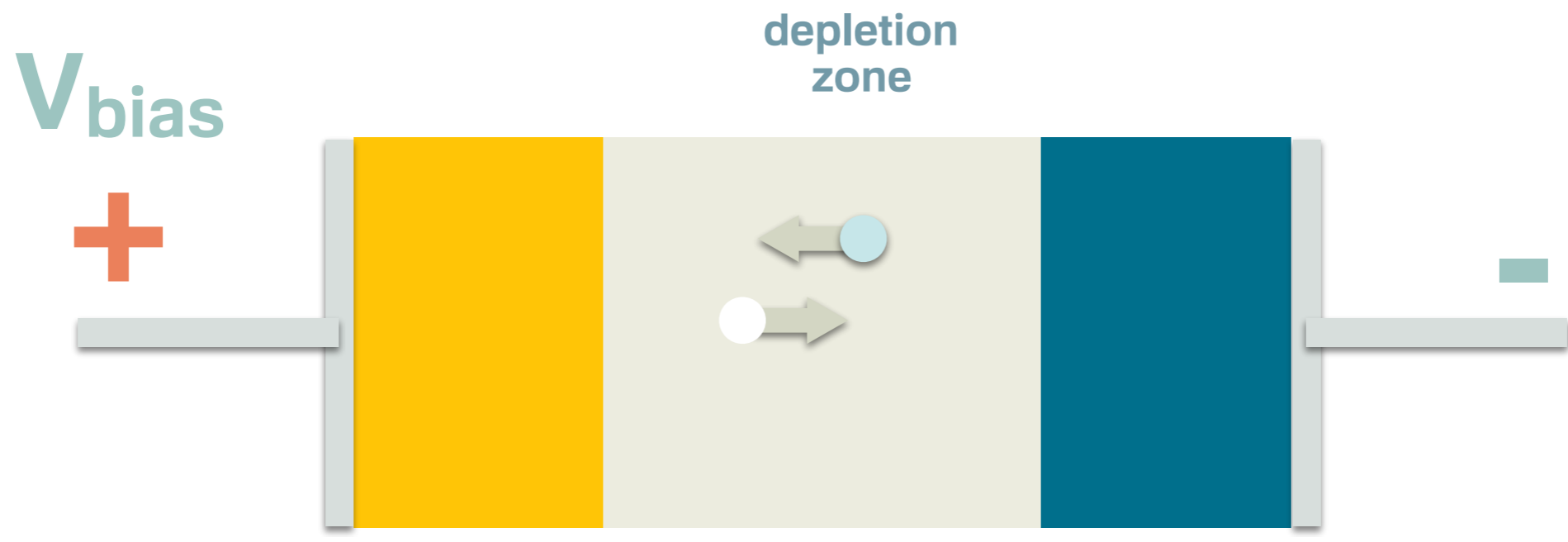
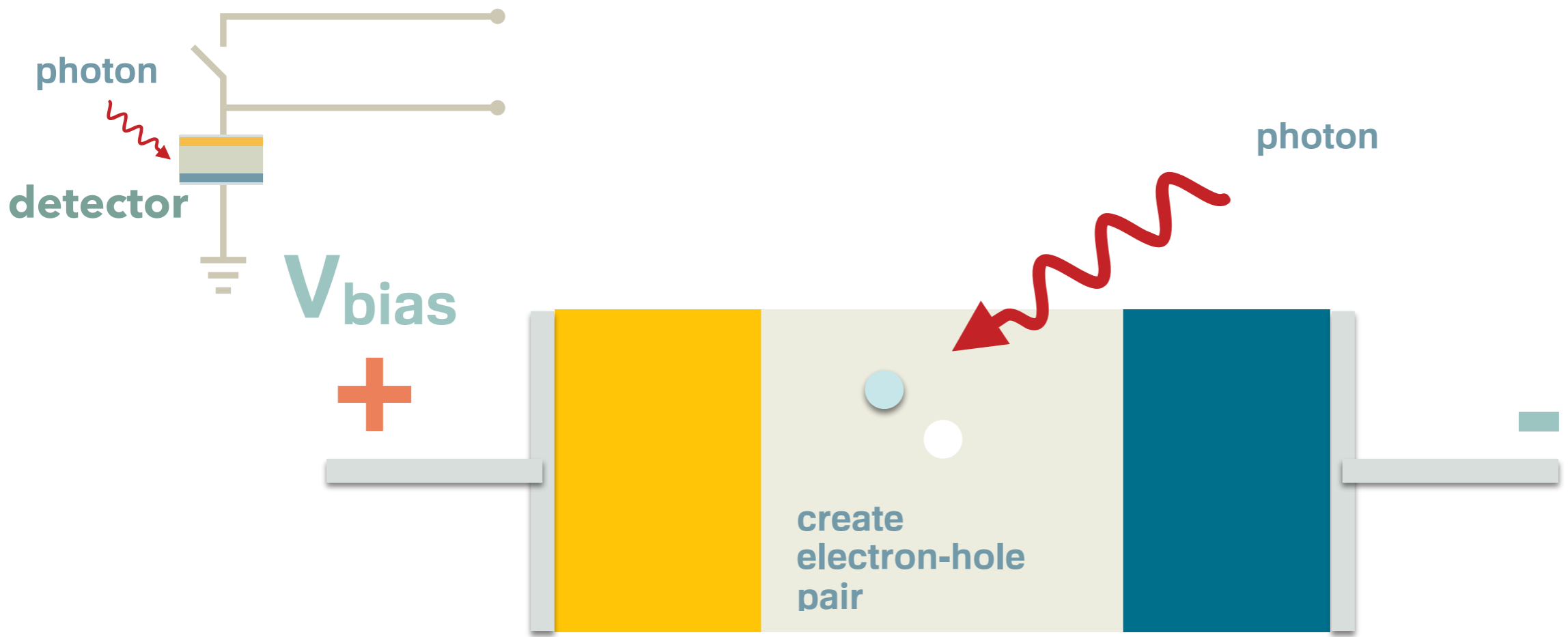

# Detector is a Capacitor

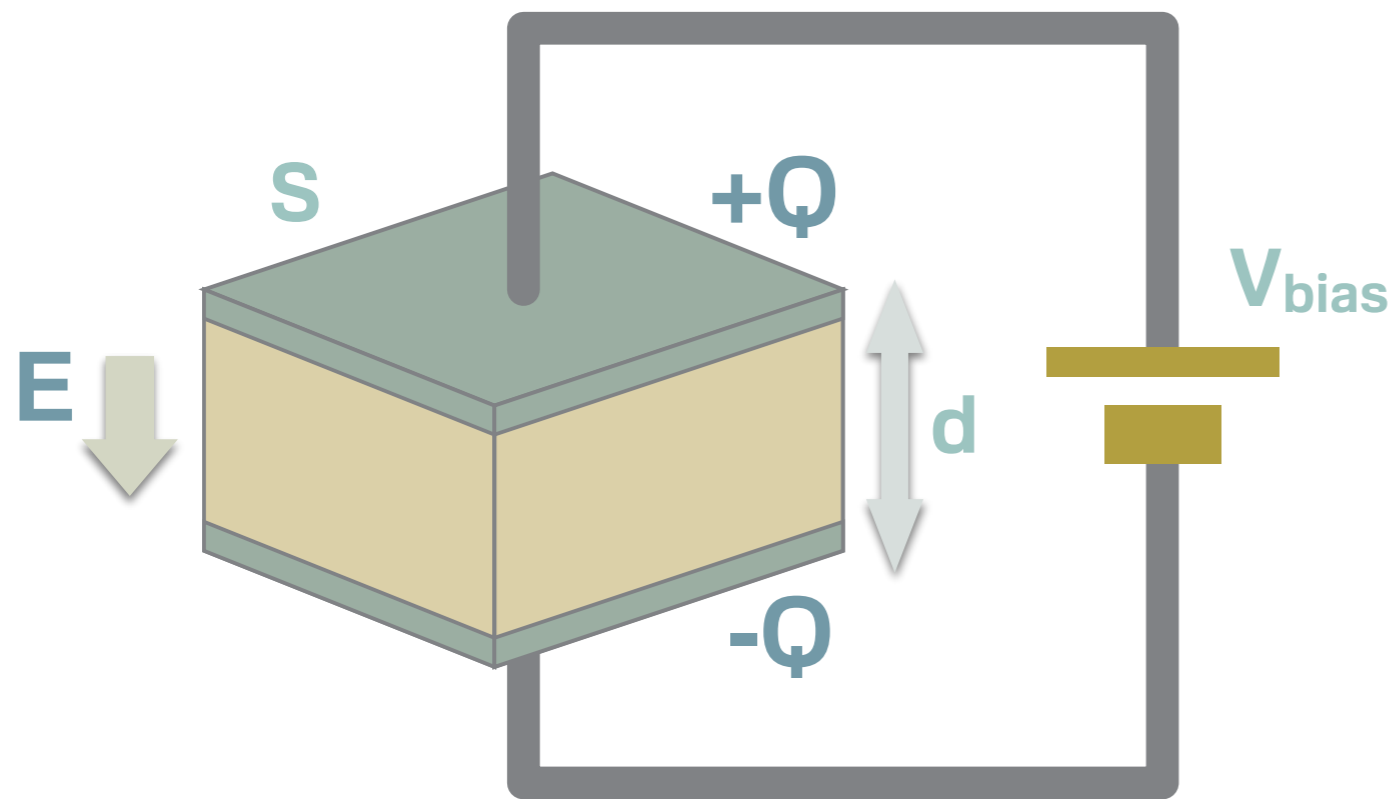

InSb  
 $\epsilon = 15\epsilon_0$

$$E = \frac{1}{\epsilon} \frac{Q}{S}$$

$$E \cdot d = \frac{1}{\epsilon} \frac{Q}{S} \cdot d$$

$$V = \frac{1}{\epsilon} \frac{Q}{S} \cdot d$$

$$Q = \frac{\epsilon \cdot S}{d} V$$

$$C = \frac{\epsilon S}{d}$$

- 1 How much electron one can charge?  
(= full well)
- 2 More pixels. What is sacrificed?

# Linearity

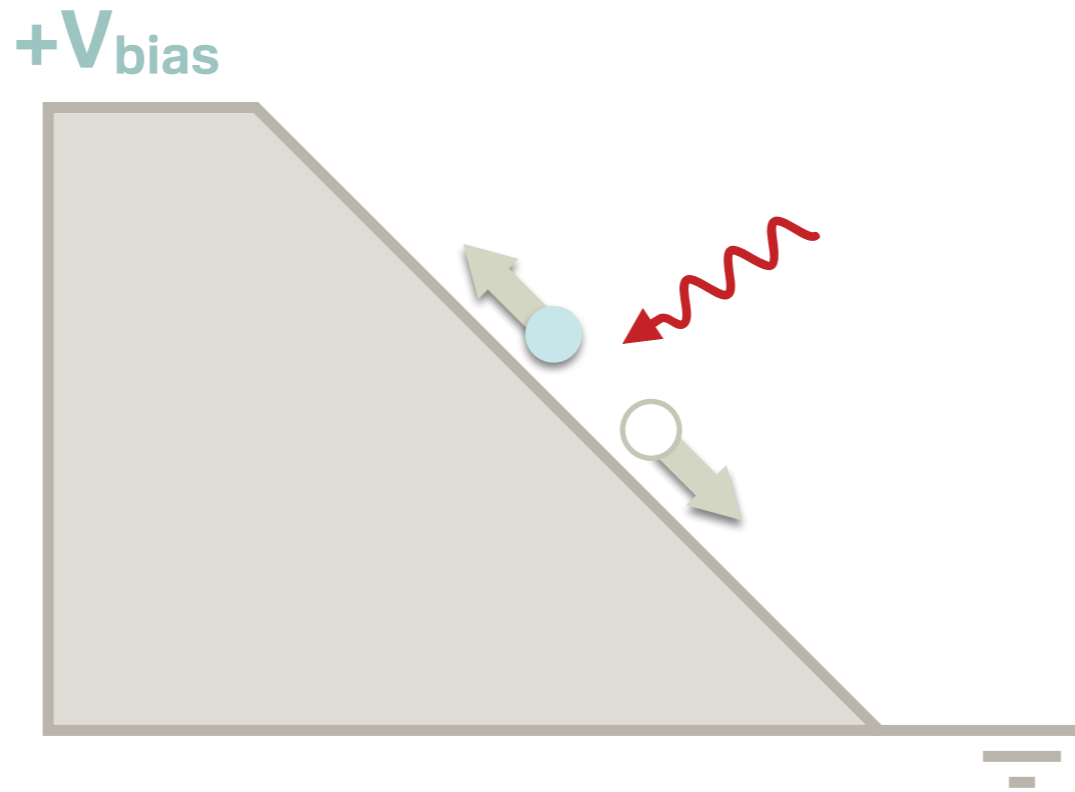
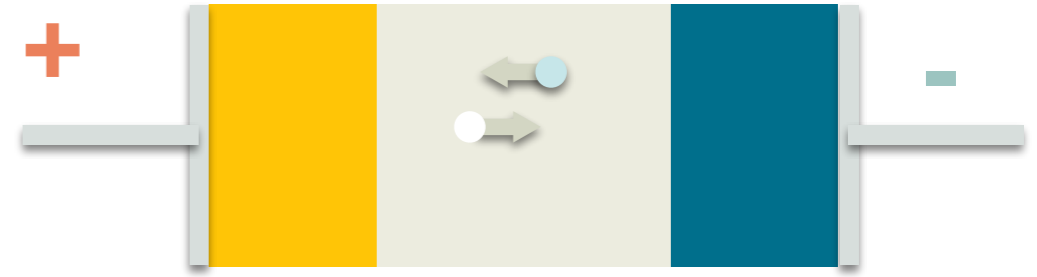

$V_{\text{out}}$

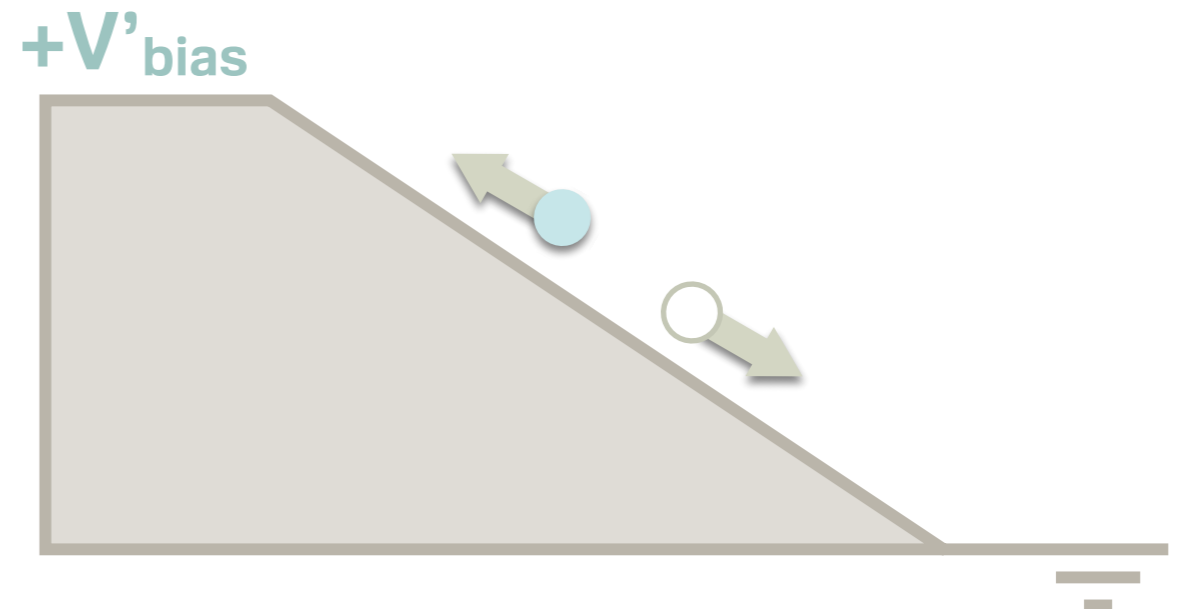
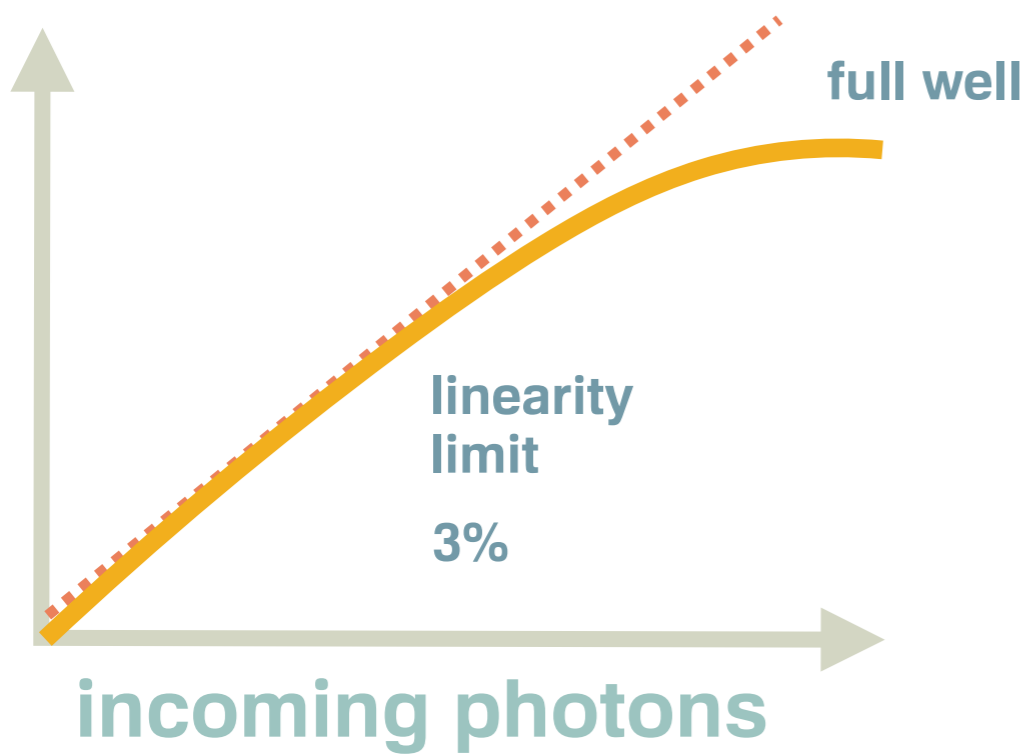

# Readout mode

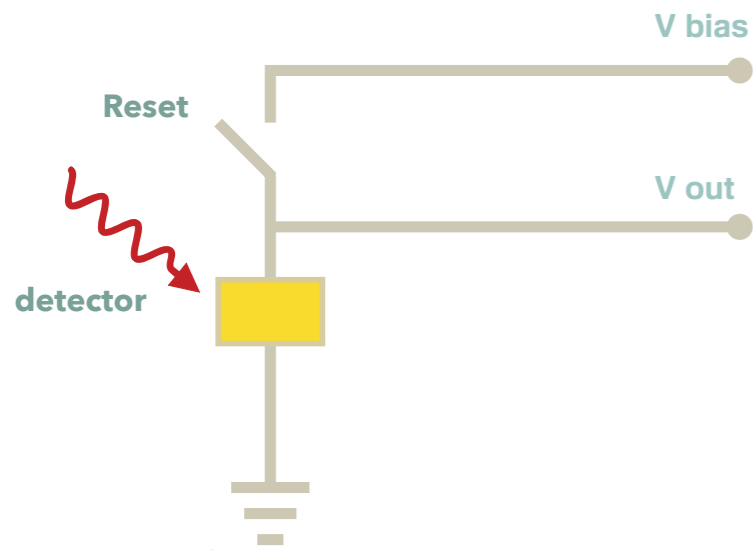

kTC Noise thermal noise  
reset noise

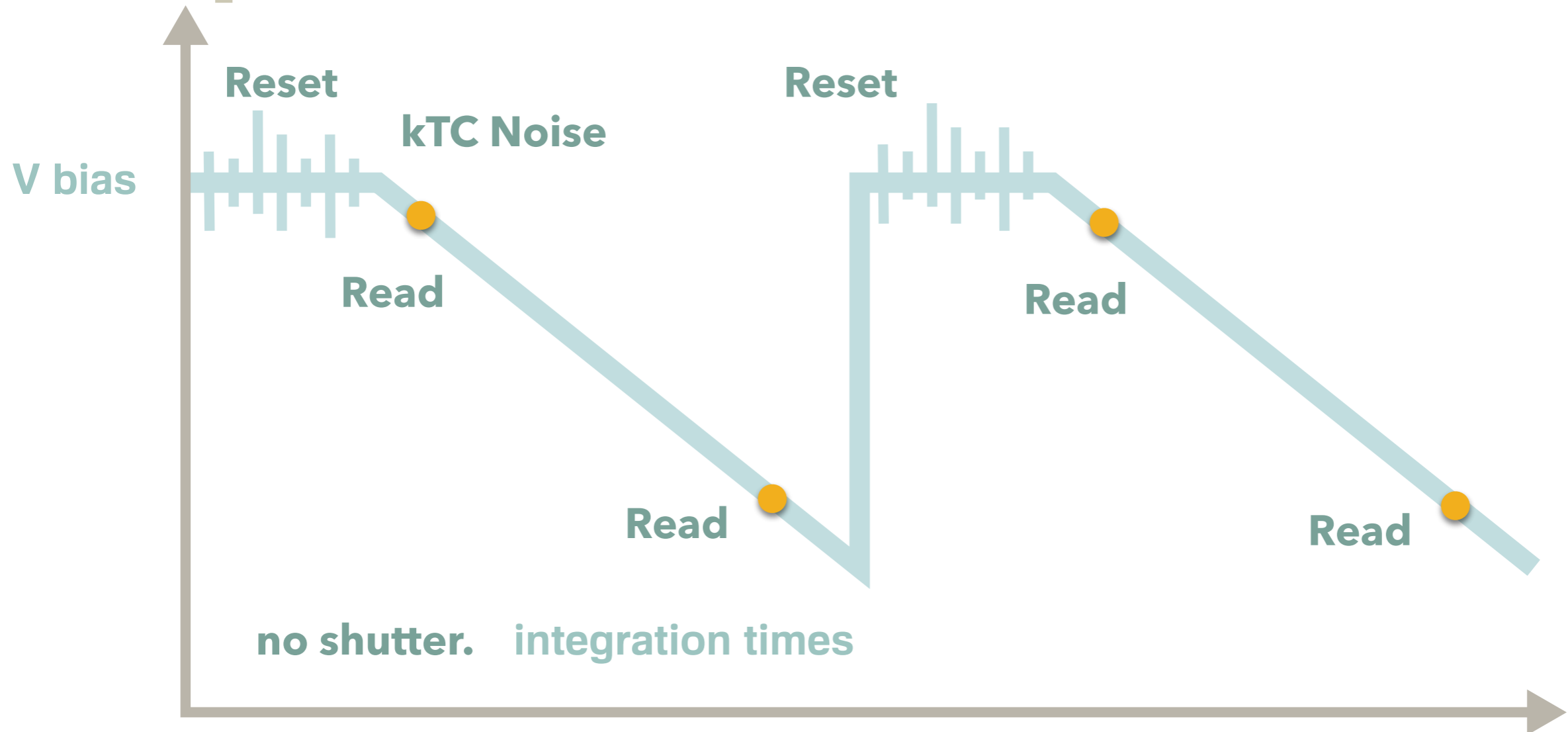

# Readout mode

## Reset-Read-Read

Vbias contains noise  
starting point of Read1 and Read2 is same  
Correlated double sampling

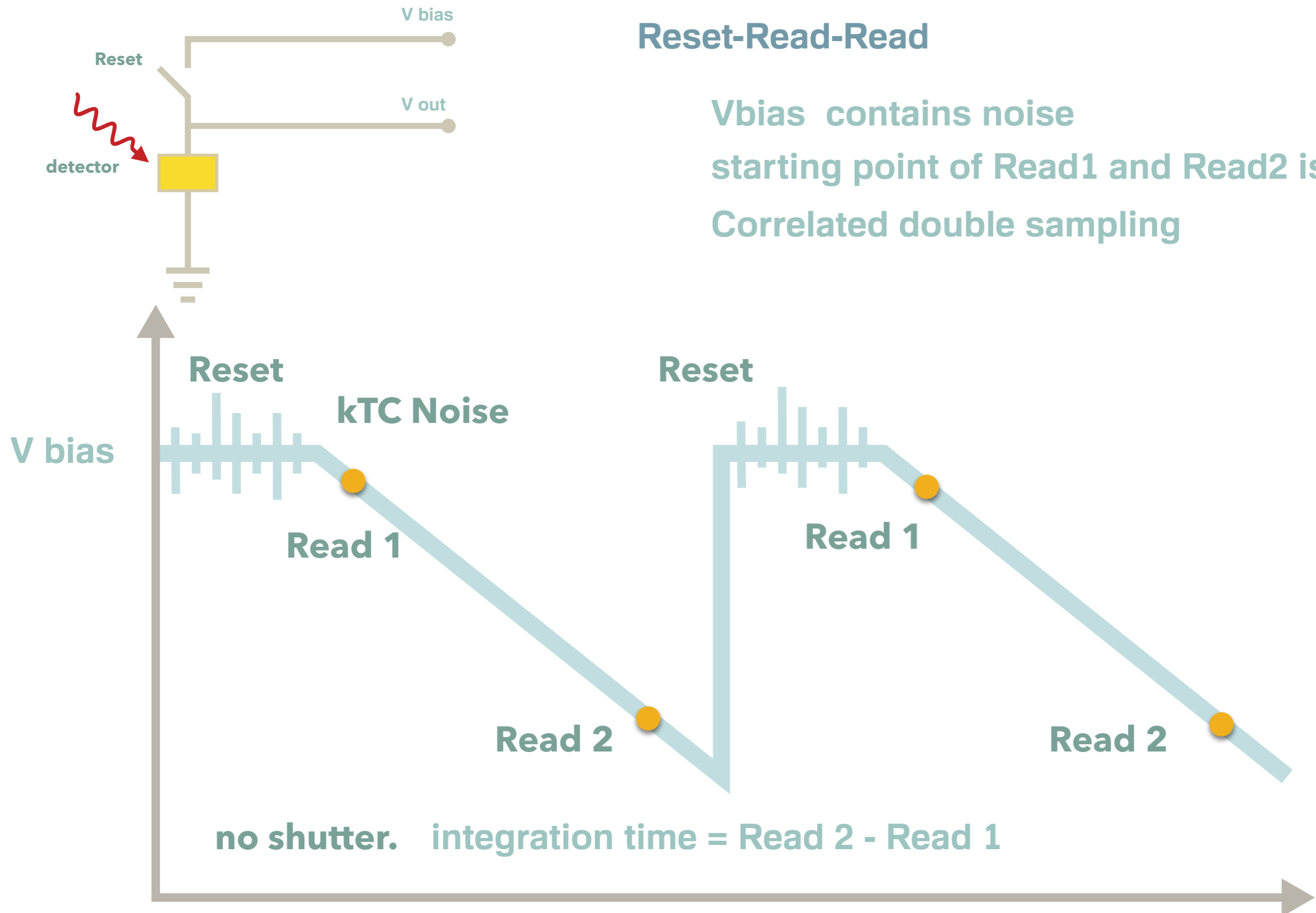

# readout mode

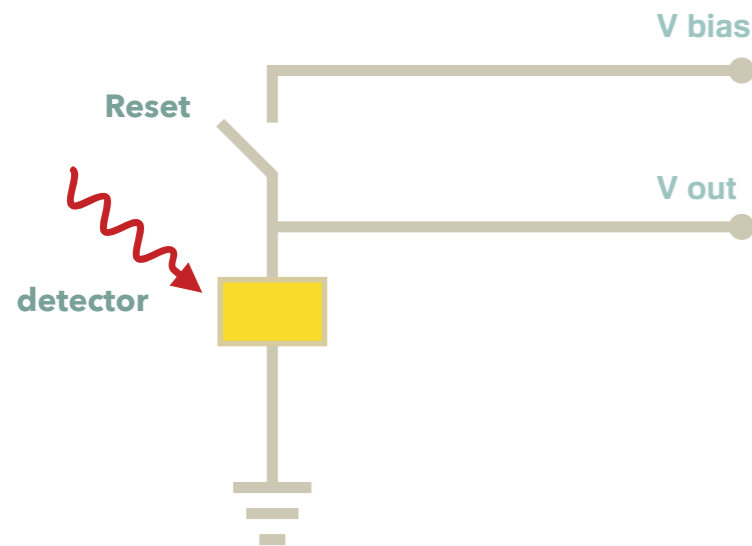

## Multiple sampling

Non destructive readout

Readout noise improves by  $\sqrt{N}$

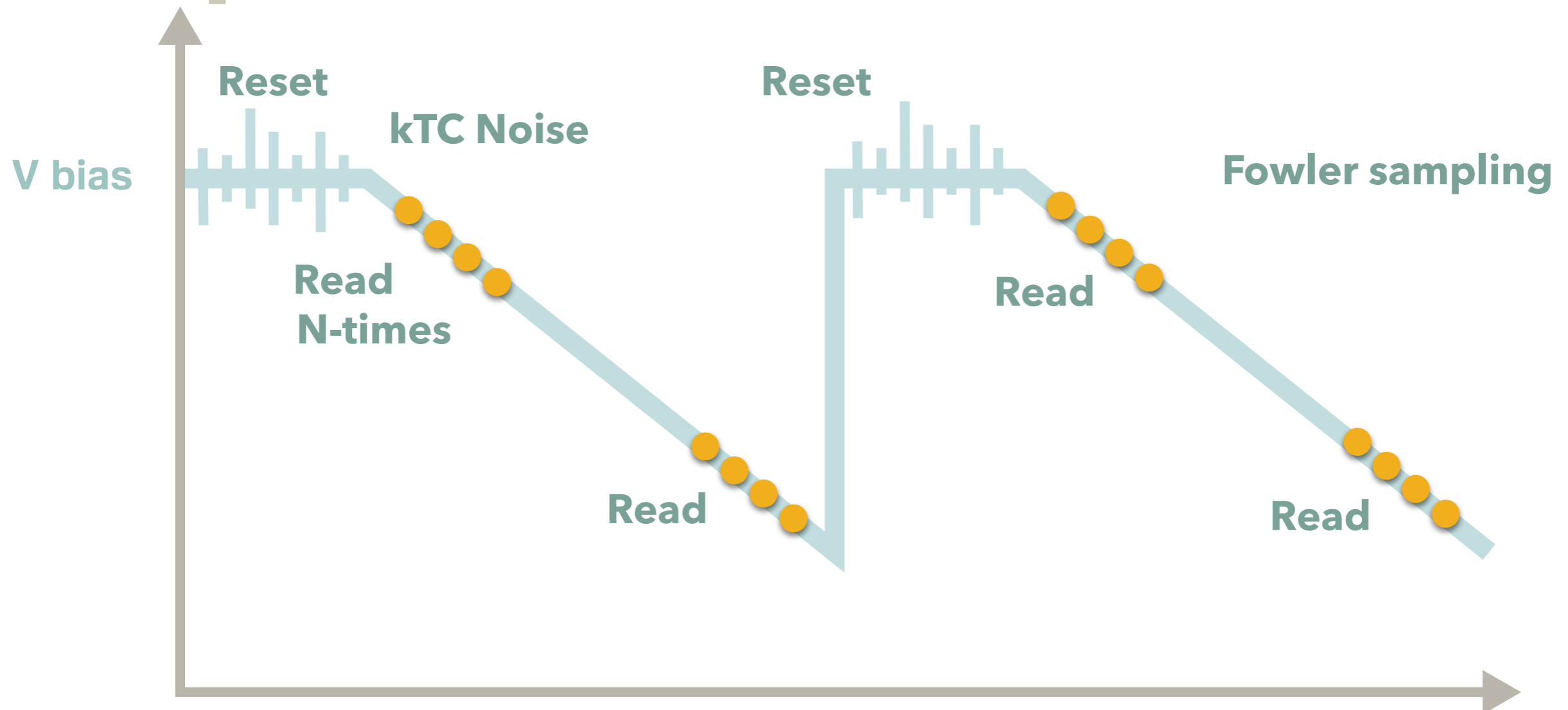



# Readout mode

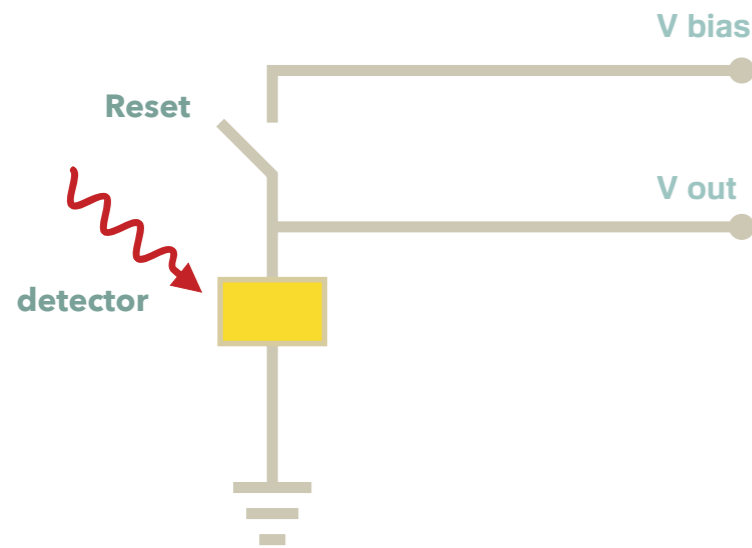

## Up-the-ramp

linearity corrected in the same time  
robust against outlier events  
electronics intensive

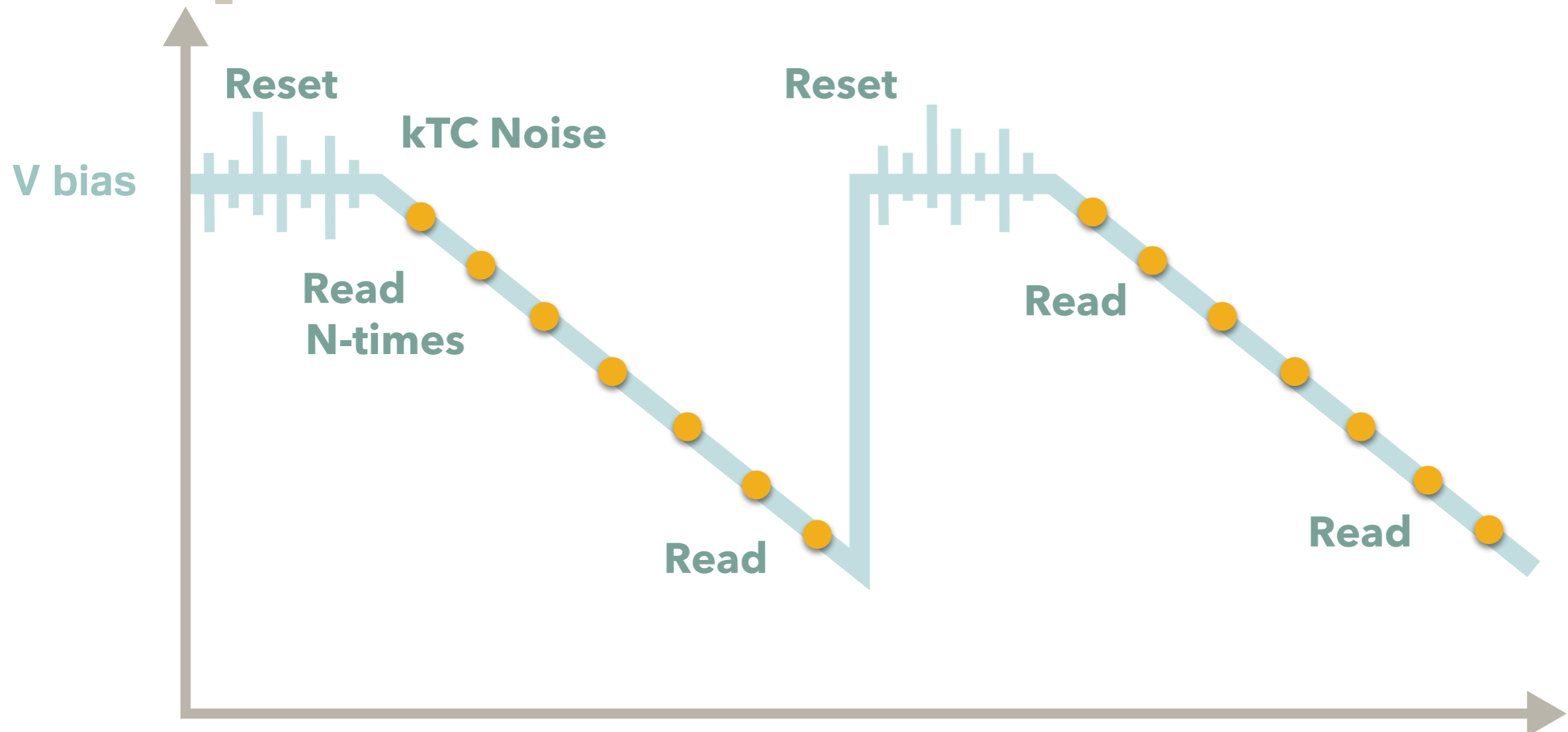

# Dark current

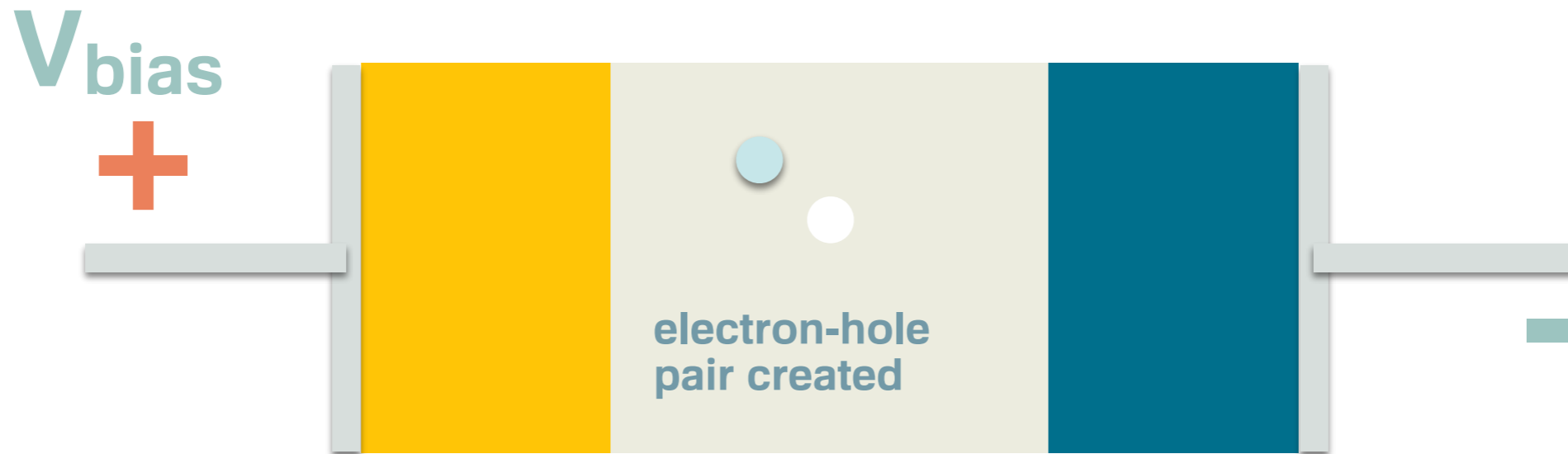

by thermal fluctuation

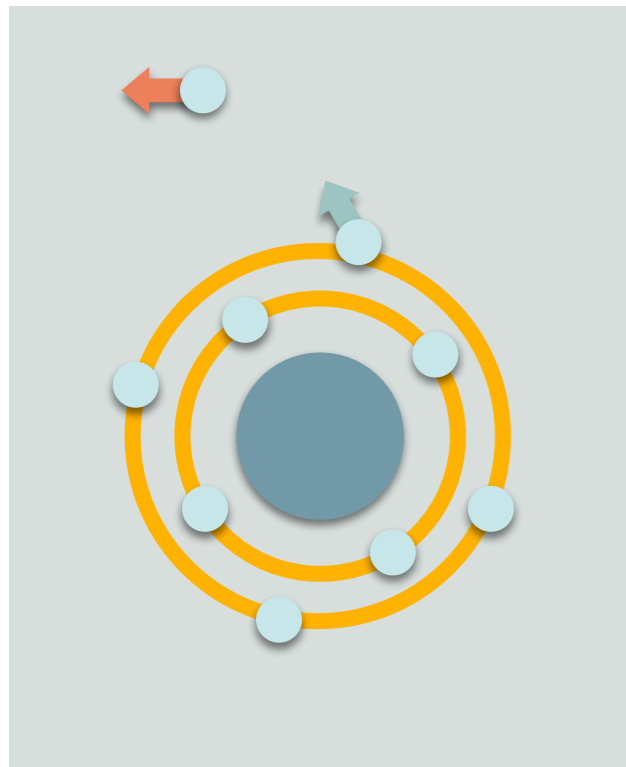

## 1 cool detector

smaller the gap, higher the dark current  
longer the wavelength  
working temperature of detector lower

## 2 use low $V_{\text{bias}}$ as possible

(but in thermal regime,  $V_{\text{bias}}$  is high in reality)

# FET : field effect transistor

How do you read out  
without losing  $V_{out}$ ?

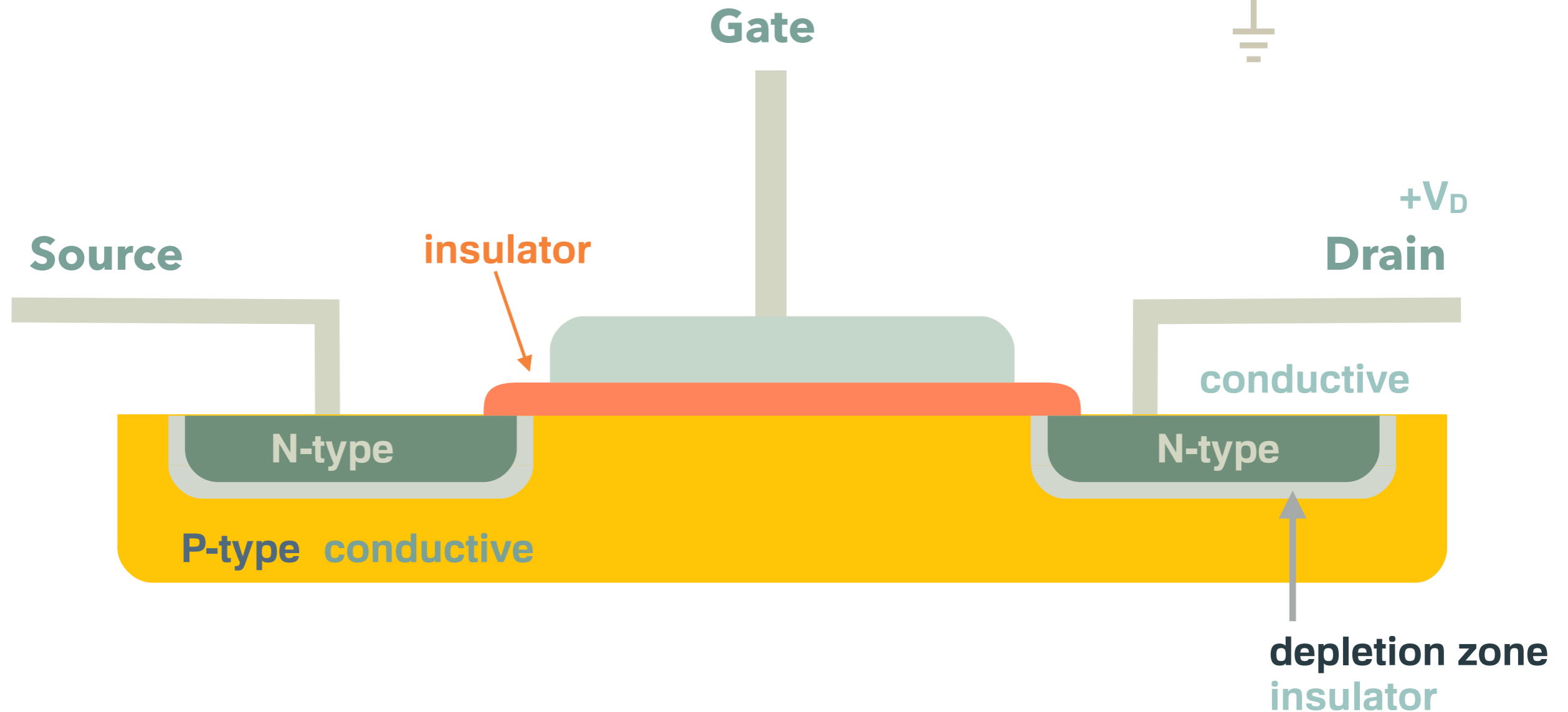
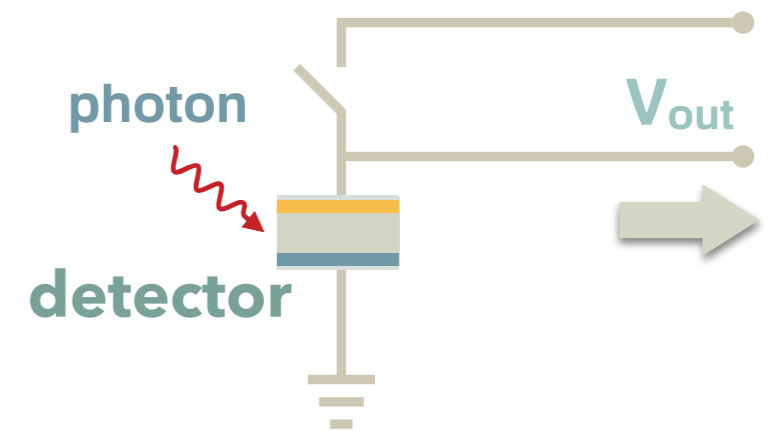

# FET : field effect transistor

How do you read out  
without losing  $V_{out}$ ?

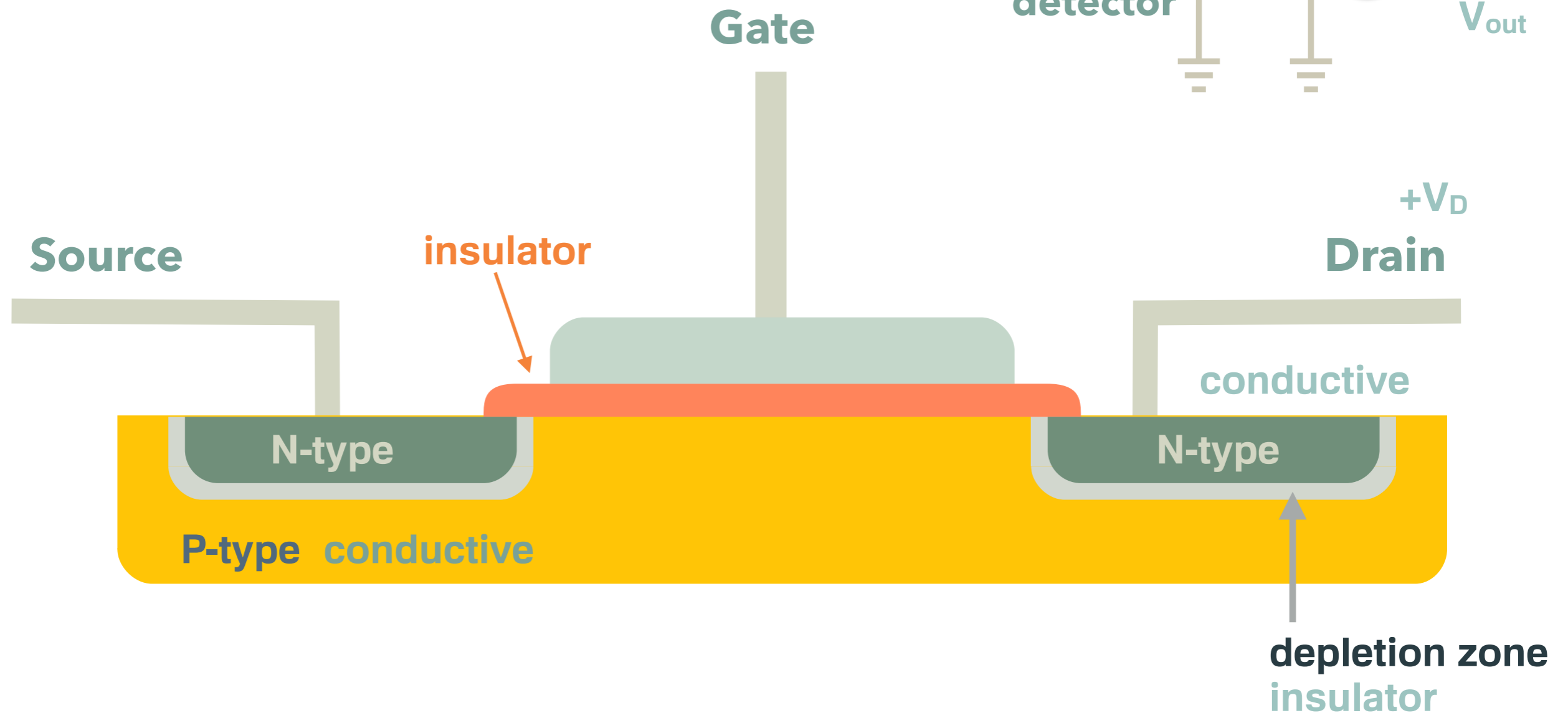
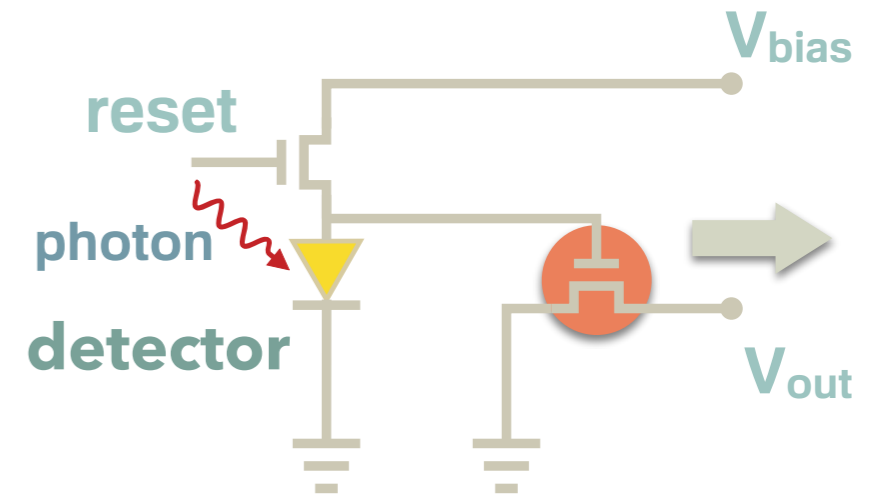

# FET : field effect transistor

How do you read out  
without losing  $V_{out}$ ?

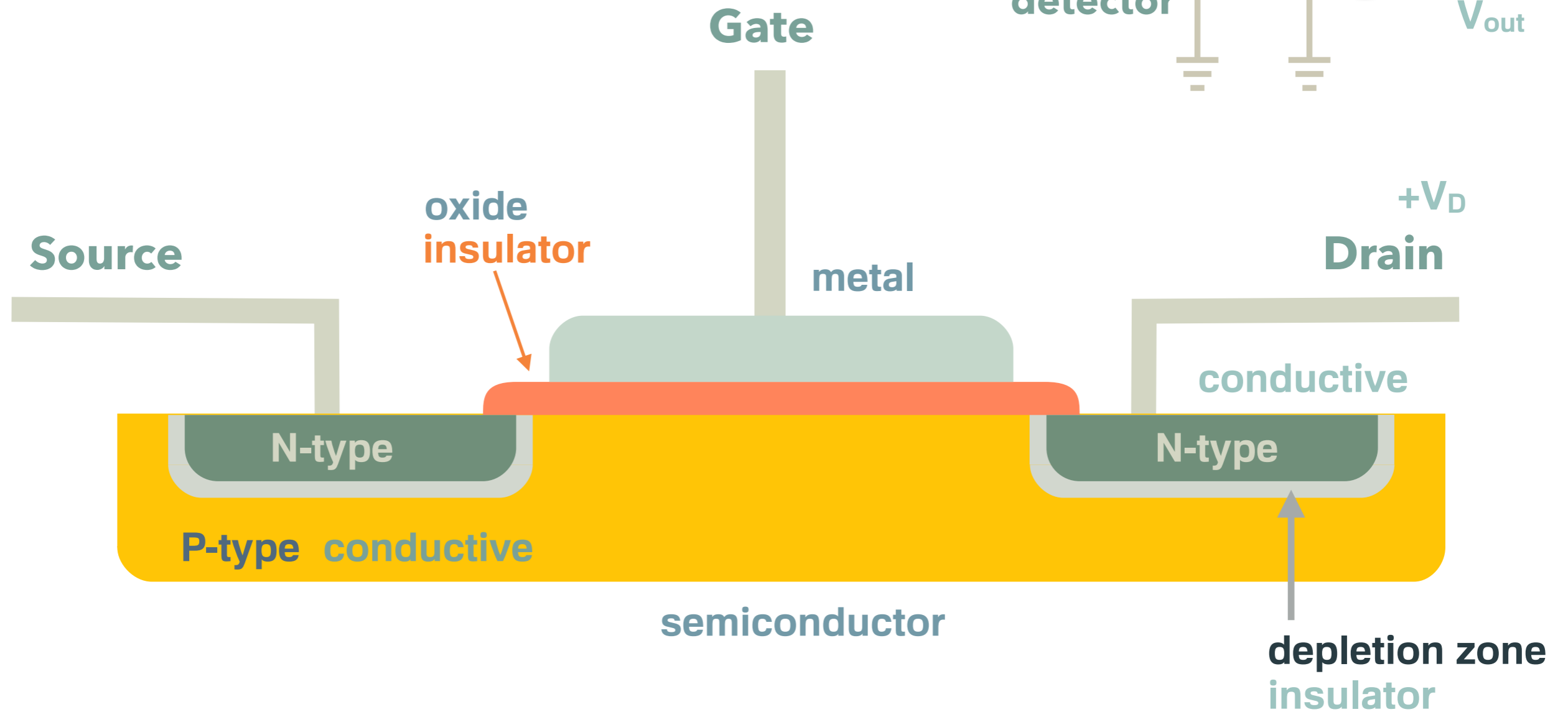
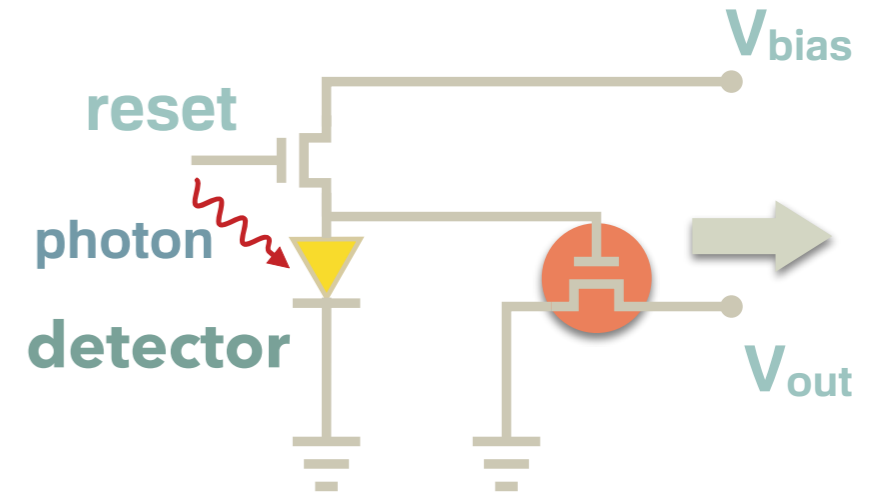

MOS : metal oxide semiconductor

# FET : field effect transistor

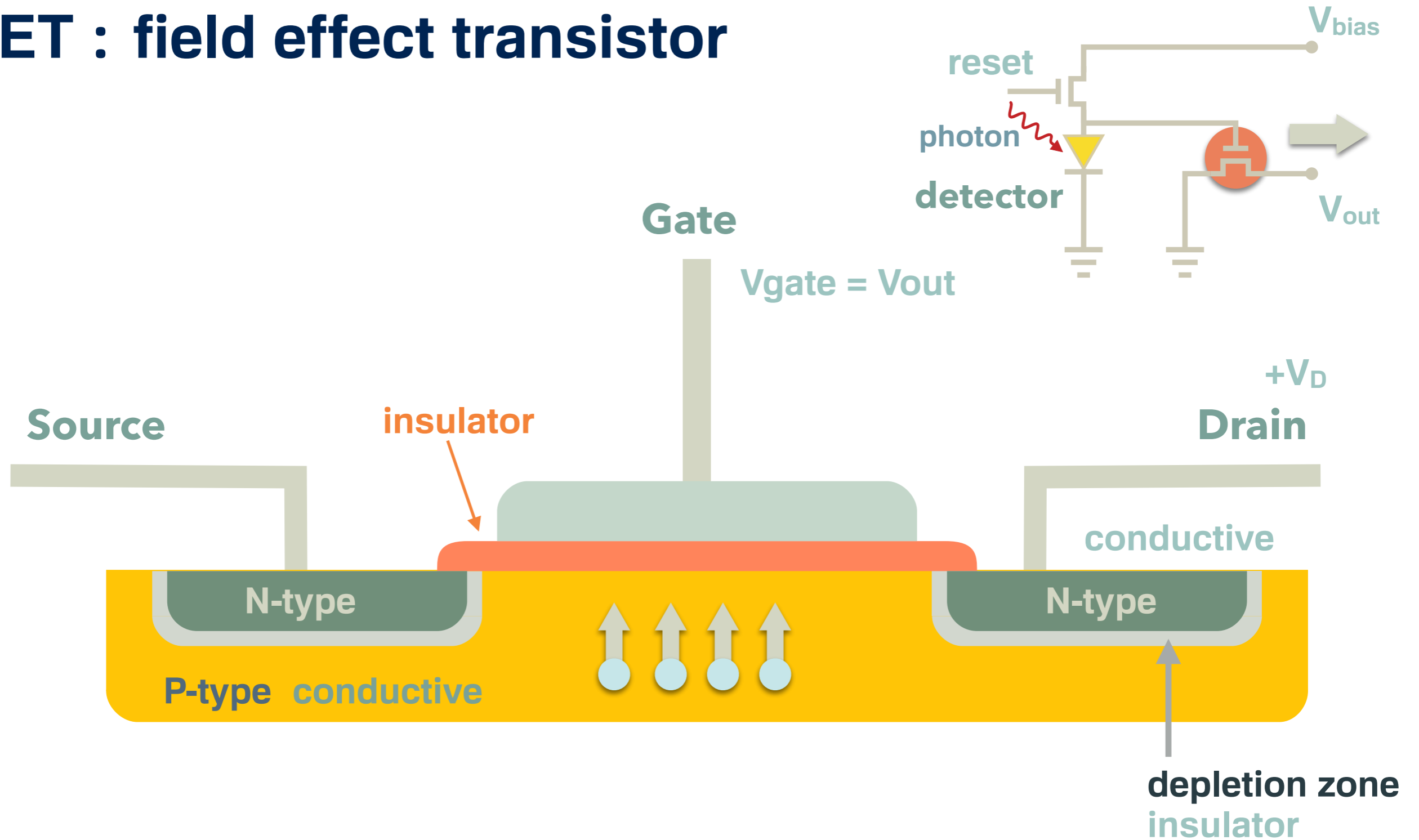

# FET : field effect transistor

thickness of new N-type layer  
proportional to  $V_{gate}$

= **Amplifier**

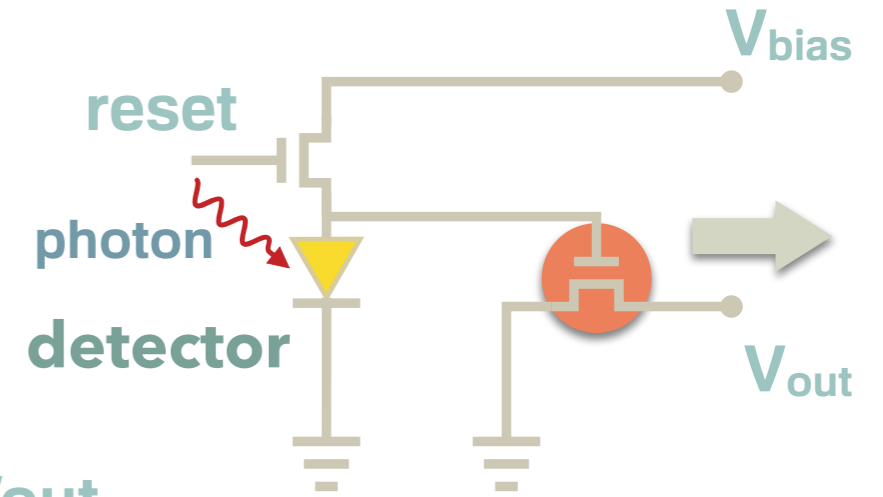
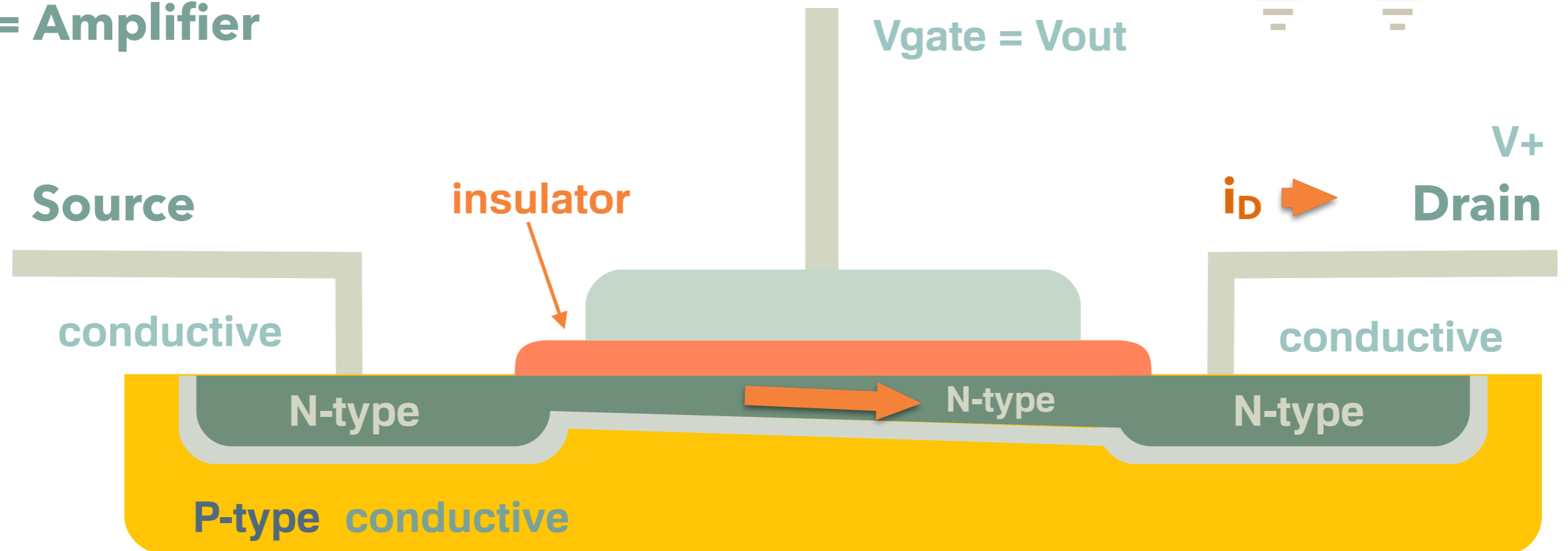

**gain** : factor

$V_{out} \rightarrow i_D \rightarrow$  AD converter  
current analog digital converter ( $\rightarrow$  ADU)

"ISO sensitivity"



# Exercise today

1 Find

$$E = \frac{1}{\epsilon} \frac{Q}{S}$$

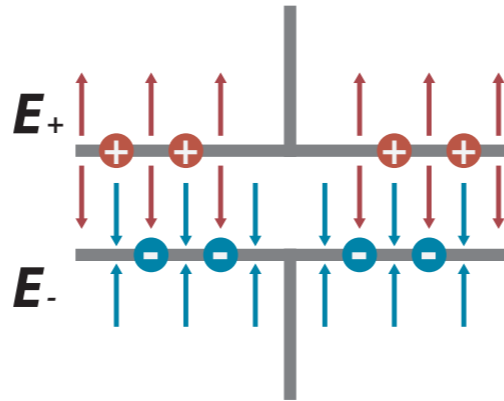

## Detector is a capacitor

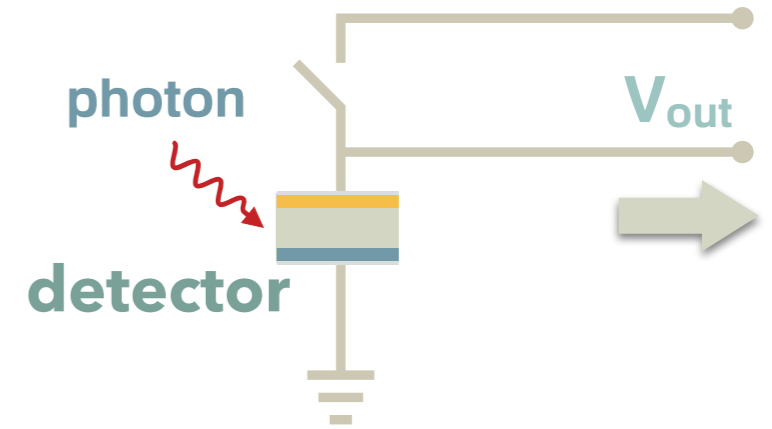

2 How much electron one can charge?  
(= full well)

pixel size  
InSb  $\epsilon = 15\epsilon_0$   $18 \mu\text{m}$   
 $\epsilon_0 = 8.85 \times 10^{-12} \text{ F m}^{-1}$   
(Farad)

$d = 15 \mu\text{m}$

$E$

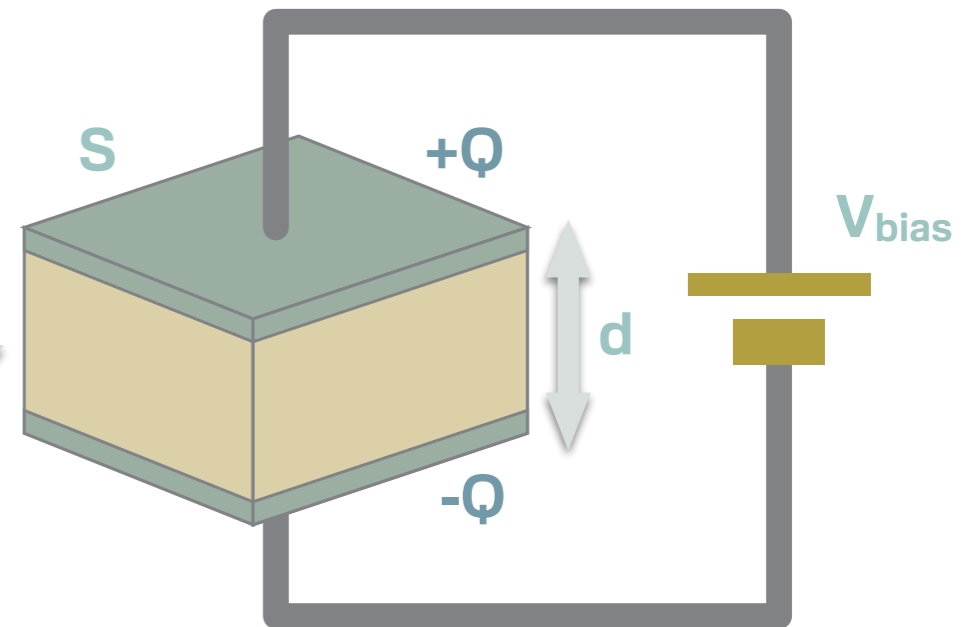

$$E \cdot d = \frac{1}{\epsilon} \frac{Q}{S} \cdot d$$

$$V = \frac{1}{\epsilon} \frac{Q}{S} \cdot d$$

$$Q = \frac{\epsilon \cdot S}{d} V$$

$$C = \frac{\epsilon S}{d} \quad (\text{capacitance})$$

3 More pixels. What is sacrificed?

Do not choose your smart phone based only on camera pixels.

Ask "how much is the dynamic range?"